

По вопросам продаж и поддержки обращайтесь:

Архангельск (8182)63-90-72
Астана (7172)727-132
Астрахань (8512)99-46-04
Барнаул (3852)73-04-60
Белгород (4722)40-23-64
Брянск (4832)59-03-52
Владивосток (423)249-28-31
Волгоград (844)278-03-48
Вологда (8172)26-41-59
Воронеж (473)204-51-73
Екатеринбург (343)384-55-89

Иваново (4932)77-34-06
Ижевск (3412)26-03-58
Казань (843)206-01-48
Калининград (4012)72-03-81
Калуга (4842)92-23-67
Кемерово (3842)65-04-62
Киров (8332)68-02-04
Краснодар (861)203-40-90
Красноярск (391)204-63-61
Курск (4712)77-13-04
Липецк (4742)52-20-81

Магнитогорск (3519)55-03-13
Москва (495)268-04-70
Мурманск (8152)59-64-93
Набережные Челны (8552)20-53-41
Нижний Новгород (831)429-08-12
Новокузнецк (3843)20-46-81
Новосибирск (383)227-86-73
Омск (3812)21-46-40
Орел (4862)44-53-42
Оренбург (3532)37-68-04
Пенза (8412)22-31-16

Пермь (342)205-81-47
Ростов-на-Дону (863)308-18-15
Рязань (4912)46-61-64
Самара (846)206-03-16
Санкт-Петербург (812)309-46-40
Саратов (845)249-38-78
Севастополь (8692)22-31-93
Симферополь (3652)67-13-56
Смоленск (4812)29-41-54
Сочи (862)225-72-31
Ставрополь (8652)20-65-13

Сургут (3462)77-98-35
Тверь (4822)63-31-35
Томск (3822)98-41-53
Тула (4872)74-02-29
Тюмень (3452)66-21-18
Ульяновск (8422)24-23-59
Уфа (347)229-48-12
Хабаровск (4212)92-98-04
Челябинск (351)202-03-61
Череповец (8202)49-02-64
Ярославль (4852)69-52-93

Единый адрес: gec@nt-rt.ru | <http://gce.nt-rt.ru>



SPECIALITY GAS EQUIPMENT

CONTENTS

1. PRODUCT INFORMATION	
Product Range	4
Product Basics.	5
Product Selection Guide	7
Order Codes	8
Regulators Overview.	9
2. STANDARD EQUIPMENT	
Regulator Series 500	13
Regulator Series 320	40
Cylinder Regulator FMD 300	43
Ultra High Purity Gas Equipment	44
Gas Panels DGS	45
Acetylene/Propane Gas Supply	47
Valves.	50
3. SPECIAL GASES EQUIPMENT	
Laser Gas Supply Equipment	55
Calibration Gas Measuring	59
Laboratory Equipment	60
4. ACCESSORIES	
Gas Management System DGM	65
Gas Monitoring System GasCom.	68
Gas Safety Protection System GSPS	70
Gas Cylinder Cabinets	71
Filtration	74
Gas Preheaters	77
Diverse Accessory	78
5. CHARTS	
Regulator Performance and Flow Charts.	91
Recommendations for Tube Dimensions	95
Conversion Tables	97
Gases Data	98

PRODUCT RANGE

STANDARD EQUIPMENT

1. PRESSURE STAGE

Brass or stainless steel

Cylinder pressure regulators FMD

Single cylinder gas panels SMD :

- Single-stage
- Dual-stage
- With process or inert gas purging

Multi cylinder gas manifolds BMD

- Single-stage, with manual switch over
- Single-stage, with automatic switch over
- With process or inert gas purging

2. PRESSURE STAGE

Line pressure regulators LMD

Point-of-use pressure regulators EMD

Accessory for wall mounted supply pressure regulators:

- Tube fittings
- Hose nozzles
- Flame arrestors
- Flow meters

REGULATING AND SHUT-OFF VALVES

Valves, brass:

- Diaphragm valves
- Pneumatic valves

Valves, stainless steel:

- Packed valves
- Diaphragm valves
- Pneumatic valves
- Valve tableaux
- Cylinder valves

Solenoid valves, brass + stainless steel

Ball valves, brass + stainless steel

Cylinder-Kombivalvee

ACCESSORIES

CONNECTION MATERIAL

Assembling material:

- Tube fittings
- C-profile rails
- Valve mounting
- Elbow tube fittings
- Straight tube fittings
- Adapter fittings
- Hose nozzles

OTHERS

Pressure gauges:

- Bourdon gauges
- Contact gauges

Cylinder connections:

- Flexible hoses
- Coils
- Extension bars
- Screwed connections

Accessory for wall mounted point-of-use tableaux

- Flame arrestors
- Flow meters
- Filters

Cylinder cabinets:

- Safety cabinets acc DIN 14470-2
- Sheet steel cabinets, TRG 280

Electric and electronic device:

- Gas insufficiency warning system
- Signal boxes
- Control device
- Gas warning systems
- Cylinder scales
- Gas heaters
- Monitoring device for pressure and flow

Gas management:

- Devices
- Software
- Gas safety systems

ULTRA HIGH PURITY EQUIPMENT

PRESSURE REGULATORS, 316L, AOD/VAR

- Line pressure regulators
- Supply pressure regulators

Diaphragm valves

Pneumatic valves

PROCESS PANELS (1. PRESSURE STAGE)

ACCESSORY:

- Coils
- Screwed connections, VCR-type

CONNECTION ADAPTERS

- Vacuum generators
- Filters
- Welding fittings

ELECTRIC AND ELECTRONIC DEVICES:

- Monitoring systems

LABORATORY EQUIPMENT

Valves, brass and stainless steel:

- Shut-off and regulating diaphragm valves

Point-of-use pressure regulators

Point-of-use equipment for laboratory furniture mounting

Point-of-use panels

Accessory for laboratory furniture

- Screwed connections
- Tube fittings
- Hose nozzles
- Connection adapters
- Flame arrestors
- Flow meter

Installation

SPECIALITY GAS EQUIPMENT KNOW HOW

HIGH-PURITY GASES REQUIRE HIGH-QUALITY REGULATORS

Proper handling of expensive high-purity gases requires the highest quality of valves and pipelines, not at least of the design, planning, installation and commissioning of the entire gas distribution system.

The fulfillment of user-specific demands such as pressure stability, flow-capacity and maintaining of the gas composition needs to be guaranteed in the same way as the prevention of contamination from the gas source down to the „point-of-use“.

Handling of compressed gases presupposes intensive knowledge of regulations and technical rules which form the basis for a safe layout of any gas-supply system.

The quality of GCEDruVa High-Purity Gas distribution system is determined by a large number of features:

- leak-tightness,
- dead-space-minimized design,
- high safety due to Hastelloy diaphragms,
- patented damping system,
- purgeability,
- intuitive out concept for joining and safety aspects.

These points require the same attention as the final assembly and preventive maintenance.



Point-of-use pressure regulator EMD

A CLOSE COOPERATION WITH OUR CUSTOMERS IS VERY IMPORTANT TO US

A close dialogue with our customers and designers enables us to develop products today which suit the market requirements of tomorrow.

Years of experience, the latest tests and measuring equipment and CAD-Technology build a basis for solutions beyond the usual expectations. Advanced product quality guarantees continuous process supply and avoids unnecessary system downtime.

Therefore the GCEDruVa technology is the sure foundation for solutions matching the customer's individual needs



Cylinder pressure regulator FMD

FINE CONTROLLABILITY OF PRESSURE AND FLOW

The quality control of all components guarantees a problem-free, safe, process gas supply, avoids unnecessary extra costs and protects the continuing efficiency of a GCEDruVa Special Gas Supply System.

Minimized leakage guarantees the necessary safety during operation ensuring, that process gases are not contaminated and ensure gas purity at the point-of-use.

ACCURACY AND SAFETY ARE THE FOUNDATIONS FOR THE HANDLING OF HIGH PURITY GASES

The selection of gas resistant and gas neutral materials, combined with precision manufacturing on numeric controlled machining centres, guarantees the utmost accuracy during the entire production process.

The mechanical manufacturing process is followed by an automated cleaning bath carefully removing any grease, emulsion, debris and solvents from the gas wetted surface.

Assembly and pressure testing is performed in clean rooms using high purity test gases.

Diverse quality inspections such as material examinations, surface roughness measurements, dimensional control, functional tests with nitrogen, pressure examinations and leakage test examinations with helium, and quality inspection of TIG-welding, safeguard the function and safety of all components and systems.



semi-automatic manifold BMD

PRESSURE REGULATORS, VALVES AND ACCESSORIES OF HIGH PURITY AND ACCURACY

GCEDruVa products meet the special requirements of high quality pure-gas distribution systems in terms of purity, pressure stability and operational safety.

The supervision and control of the material quality is decisive for quality and safety of the products. Components which undergo electro-polishing and multi stage cleaning processes achieve highest quality surface, are generally ECD-suitable and in combination with 316L, Hastelloy inner parts and properly purged, are extremely corrosion resistant.

Minimal leakage rates avoid any gas contamination and increase the safety for the operators.

Both the design of the metal diaphragm, valves and regulators as well as solely using HASTELLOY material for the diaphragms, guarantees highest safety against leakage in the regulator or damage to the.



Line regulator LMD

APPLICATION AREAS FOR GCEDRUVA SPECIAL GAS EQUIPMENT

- Analysis technology
- Gas chromatography
- Atomic-Adsorption-Spectrometry
- Exhaust-gas measurement for environmental control
- Chemical process technology
- Laser technology
- Pharmaceutical industry
- Petrochemical industry
- Food / drugs sector
- Semiconductor technology
- Fibre optical industry

QUALITY STANDARDS

GCE QUALITY MANAGEMENT

GCEDruVa clean-gas systems prove its quality by performance and reliability. The production process of the regulators is certified according to ISO9001 and ISO13486 at regular intervals. This certification is considered by GCEDruVa as only one step in the long path towards not only gaining and keeping the confidence of our customers in our products but also to strengthen it. Unannounced re-audits by internal and external supervisors assure a continuous quality level.

Therefore our customers can rely on these certificates not being used as a basis to relax but as a stepping stone to new heights with regards to quality and performance. It is our aim to be a reliable partner to our customers in all questions about pure gas technology with economical solutions to their individual problems through well engineered technology.

The most important steps for the fulfilment of these expectations are:

- optical measurement control max. 100%,
- microscopic and endoscopic test of all bored holes,
- multi-stage special cleaning with DI-water cleaning process, clean air flushing and material friendly drying,
- functional tests,
- 12-hour-pressure test at nominal pressure ,
- Helium-leakage-test with mass spectrometer.
- 100% function and tightness control of basic components.

SERVICING

To guarantee the safety, dependability and longevity of an installed special gas supply system every company should make sure that the necessary safety-related equipment-parts are tested , for condition and functionality at reasonable intervals, not more than one year, in accordance with BGV B6 §53 Article 2.



Helium leak testing

HELIUM LEAK RATE CERTIFICATION

Helium leak testing is performed using a mass spectrometer. This technique is particularly effective at detecting and quantifying very small leaks. For example a typical regulator might have a helium leak rate of 3×10^{-9} mbar l/sec He equivalent. This is equal to a leak of just 1 cm³ in 30 years with a pressure difference of 1 bar at the component. Some products for the electronics industry or high corrosion service will be separately helium leak tested and certified as standard to guarantee maximum integrity. Many other components are given a guaranteed but uncertified maximum leak rate. For these components helium leak testing is available upon request and certification is an optional.

PURGE

Purge utilises a sequence of pressurisation followed by de-pressurisation by venting. It is recommended to repeat this simple sequence 10 times. The so called **process gas purging** uses the process gas for purging, **inert gas purging** is performed with an inert gas through a special inlet connection.

Purging with an external inert gas is an extremely important factor when changing cylinders for the following reasons:

1. Purging the gas remaining in the system before cylinder changing improves the safety level for the operator.
2. Maintaining gas purity by purging the atmospheric air which has penetrated the system after cylinder changing.
3. Purging with dry inert gas reduces humidity and extends the expected lifespan, when corrosive gases are used.

For **high purity gases** purging will remove air/moisture from the system before process gas is introduced in order to preserve the purity of the gas and to promote system reliability.

For **toxic gases** purging will remove process gas out of the system before the system is opened to atmosphere and will therefore minimise the risk of operator's exposure.

For **corrosive gases** purging will remove moisture from the system. Moisture can produce strong acids and potentially solid material which can cause system failure through corrosion and/or particular contamination.

FLOW CAPABILITIES - PERFORMANCE CHARTS

For regulators the concept of flow coefficient is only partially useful in demonstrating the performance (Kv is dependent upon upstream and downstream pressure). GCEDruVa uses, as a rule, performance charts pursuant of ISO 2503 (upstream pressure of approximately double the downstream pressure. E.g. : $p_1 = 101$ bar and $p_2 = 50$ bar) as a result the performance of the GCEDruVa regulator flow charts are based on a comparable test method. Since the upstream pressure of a regulator is usually higher than double the downstream pressure (pursuant ISO) the resulting actual flow rates to be expected will be considerably higher than in the ISO performance charts are showed. For more detailed information concerning maximum and minimum obtainable flow rates, dependent upon type of gas, temperature etc. - please contact our technical division.

PRESSURE REGULATORS DENOTATION

CYLINDER PRESSURE REGULATORS (FMD)

Cylinder regulators are used to reduce the cylinder pressure to a lower usable level.

LINE PRESSURE REGULATORS (LMD)

Line regulators are designed to reduce line pressure for subsequent equipment

POINT-OF-USE REGULATORS (EMD)

Point-of-use regulators are used to give maximum accuracy and shut-off capability at the Point-Of-Use - POU.

GAS PANELS (SMD, BMD)

Gas supply panels are installed in the gas storage area (cylinder stock room or gas cabinet). They reduce cylinder / tank pressure to the desired line pressure for in-house use. Via the subsequent piping system the gas will be guided to the point-of-use.

ULTRA HIGH PURITY REGULATORS

These Ultra high purity regulators were specially designed to maintain the ultra high purity of the gas inside the regulators. Polished surfaces, the use of metal diaphragms, minimized dead space and specially designed seals and seats minimizes or rather eliminates the risk of out gassing and inboard diffusion or gasket contamination.

PRODUCT SELECTION GUIDE

QUESTIONS TO BE ANSWERED SELECTING A REGULATOR

Do you need a standard regulator/valve (gas purity < 6.0) for ultra high-purity use (higher 6.0)?
 Do you need a single-stage or dual-stage regulator?
 Do you need a purge system? See information on previous page.
 The construction material does not need be specified as it depends on gas type. GCEDruVa will automatically tailor it's proposal to makes a proposal to the chosen gas.
 Which outlet pressure range is required (specification in "Technical data")?
 Which flow rate is required (Specification on product specific flow charts, precise information for specific gases and types can be obtained from our technical department)?
 Do you have a 200 or a 300 bar gas supply level?
 Which type of inlet connection (cylinder connection) do you need, DIN or another national norm?
 Which kind of outlet connections do you need: tube fittings, hose nozzles etc.?



SINGLE-STAGE REGULATORS

High pressure mediums enter through the inlet of the regulator to the high pressure chamber. When the hand wheel is turned clockwise, it compresses the spring and creates a force on the diaphragm, which pushes the regulator's poppet open. This releases the gas into the low-pressure chamber, exerting an opposing force on the diaphragm which then closes the passage. Equilibrium is reached, when the spring force on the diaphragm is equal to the opposing force of the gas in the low-pressure chamber.
 In a single-stage regulator, delivery pressure increases as cylinder pressure falls, because there is less gas pressure exerted on the diaphragm. Thus, frequent adjustment of the control knob is required to maintain a constant delivery pressure. Therefore a two-stage regulator is recommended for applications requiring constant outlet pressure, With the two stage regulator the point of use pressure stays practically constant, irrespectively of the cylinder pressure which sinks progressively as the cylinder empties.

DUAL-STAGE REGULATORS

A dual-stage regulator functions like two single-stage regulators connected in line. The first stage reduces the inlet pressure to a preset intermediate pressure. By adjusting the control knob the second stage reduces the intermediate pressure to the desired delivery pressure.
 Like the single-stage regulator, outlet pressure from the first stage of the two-stage regulator rises as cylinder pressure decreases. However, the second-stage of the dual-stage regulator regulates, according to the preset level entered with the control knob, the point of use pressure as desired. Thus, delivery pressure remains constant even as the cylinder pressure lowers, eliminating the need for frequent control knob adjustment needed for a single-stage regulator.

GAS PURITY VALUES

Gas type	Purity- [degrees]	Purity	Max. Contamination (ppm)
Pure gas	2.5	99.5%	5000
	3.0	99.9 %	1000
High purity gas	3.5	99.95 %	500
	4.0	99.99 %	100
	4.5	99.995 %	50
	5.0	99.999 %	10
	5.5	99.9995 %	5
	6.0	99.9999 %	1.0
Ultra pure gas	7.0	99.99999 %	0.1

CENTRAL GAS SUPPLY

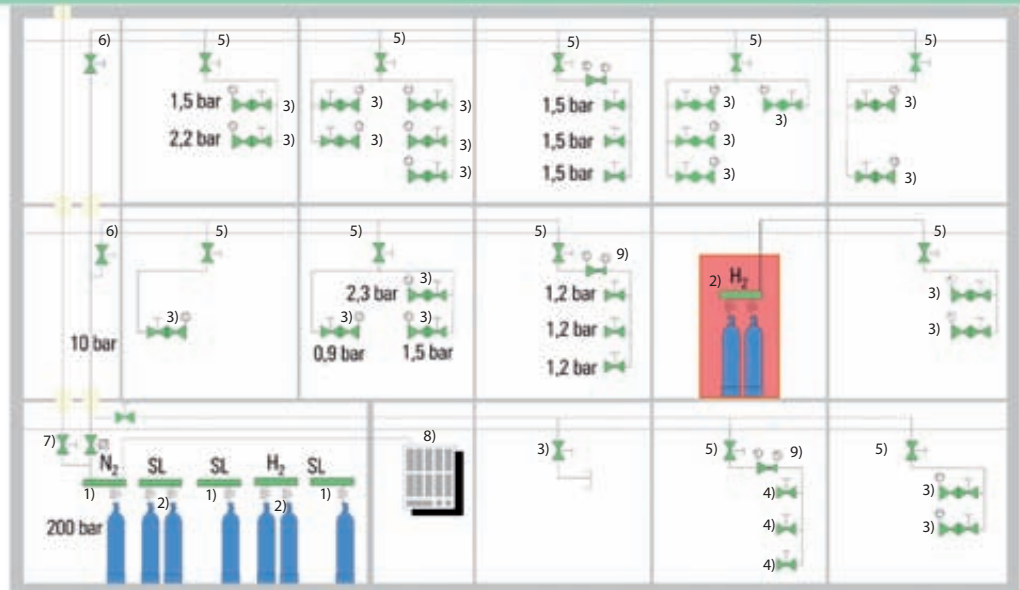

- 1) Gas panel SMD,
- 2) Gas manifold BMD,
- 3) Point-of/use regulator EMD,
- 4) Point-of-use shut-off,
- 5) Room shut-off,
- 6) Floor shut-off
- 7) Central shut-off,
- 8) Gas management,
- 9) Line regulator

ORDER CODE FOR YOUR PRESSURE REGULATORS

Series	500	3100	320	100
Purity	≤ 6.0	≤ 6.0	≤ 5.0	for techn. Gases and Laser gases
Application	Standard	Laboratory	diverse	diverse

FMD 50 0 -16 B F 200 DIN CL6 BC 0 Gas

APPLICATION AREA

FMD = cylinder pressure regulator
 SMD = gas supply panel for 1 cylinder
 BMD = gas supply manifold for 2 or more cylinder
 LMD = line regulator
 EMD = point-of-use regulator

TYPE OF PRESSURE REDUCING

50 = standard regulators
 51/52 = supply into vacuum
 54/56 = low outlet pressure
 53 = special 315 bar inlet pressure regulators

PRESSURE STAGES

0 = single-stage
 2 = dual-stage

TYPE (IDENTIFIED BY OUTLET AND PURGING)

-14 = with outlet tube fitting
 -16 = outlet shut-off valve
 -18 = outlet metering valve
 -21 = external gas purging
 -24 = panel with process gas purging
 -25 = panel with process gas purge and downstream shut-off valve
 -26 = inert gas purging
 -27 = inert gas purging and downstream shut-off valve
 -29 = for acetylene (C₂H₂)
 -30 = panel with outlet shut-off valve, no purge
 -32 = panel with outlet shut-off valve, with process gas purge
 -34 = panel with semi-automatic switch-over, with inert gas purge
 -35 = panel with semi-automatic switch-over, with process gas purge
 -39 = panel with semi-automatic switch-over, without purge

MATERIAL

B = brass
 BC = brass chrome-plated
 SS = stainless steel

GAS TYPE OPTIONAL

0 = without
 KI = contact gauge

MATERIAL OF OUTLET FITTING

B = brass
 BC = chrome-plated brass
 SS = stainless steel

OUTLET FITTING

CL0 = without,
 CL3, CL6, CL8*, CL10, CL12
 (CL6 = NPT-tube fitting for tube outside diam. 6 mm)
 NO6, NO8, NO10 = hose nozzle for tube with inside diameter 6/8/10 mm

CYLINDER CONNECTION

DIN = DIN
 A = ANSI
 F = AFNOR
 B = NBN
 UK = BS 341
 US = CGA
 NL = NEN
 others on request

OUTLET PRESSURE LEVELS (DEPENDS ON SERIES TYPE)

bar	psi
0.02 - 0.25	0.3 - 2
0.2 - 1	3 - 15
0.2 - 2 abs	3 - 30 abs
0.2 - 2.2	3 - 33
0.2 - 3	3 - 45
0.2 - 3 abs	3 - 45 abs
0.2 - 4	3 - 60
0.5 - 6	7 - 85
1 - 10.5	15 - 150
1 - 14	15 - 200
2.5 - 28	35 - 400
2.5 - 50	35 - 720
10 - 200	145 - 2900

INLET PRESSURE (DEPENDS ON SERIES TYPE)

	bar	psi
C =	6	85
D =	12/14	175/200
E =	40/50	600/720
F =	230	3300
G =	315	4500

EXAMPLE ORDER CODE

Armature	Type	Material	inlet pressure	Outlet pressure	inlet	Outlet	Contact-gauge	Vent-piping	Gas type
FMD 532	-14*	BC	G	10	DIN	CL6 BC	Ki	A	Gas
	-14	BC = brass-chrome	G = 315 bar	3 = 0.2 - 3 bar	DIN	CL6 (standard)	0 = without Ki = with	0 = without A = with (only in conjunction with RV)	Please specify
	-16	plated		6 = 0.5 - 6 bar	ANSI	CL 1/8"			
	-18	SS = stainless steel		10 = 1 - 10.5 bar	AFNOR NBN	CL 1/4" BC = brass-chrome pl. SS = stainless steel			

PRESSURE REGULATORS OVERVIEW

CYLINDER PRESSURE REGULATORS 500 OVERVIEW

Outlet: tube fitting



Outlet: shut-off valve



Outlet: regulating valve



With inert gas purging
Stainless steel



Type -27 with shut-off valve at outlet
Type -26 without

SINGLE-STAGE - 200 BAR

FMD 500-14

Inlet pressure: 230 bar / 3300 psi
Outlet pressure: 6, 14, 28, 50, 200 bar
85, 200, 400, 720, 2900 psi

FMD 500-16

Inlet pressure: 230 bar / 3300 psi
Outlet pressure: 6, 14, 28, 50, 200 bar
85, 200, 400, 720, 2900 psi

FMD 500-18

Inlet pressure: 230 bar / 3300 psi
Outlet pressure: 6, 14, 28, 50 bar
85, 200, 400, 720 psi

FMD 500-26/-27

Inlet pressure: 230 bar / 3300 psi
Outlet pressure: 6, 14, 28, 50, 200 bar
85, 200, 400, 720, 2900 psi

FMD 510-14

Inlet pressure: 12 bar / 175 psi
Outlet pressure: 0.2 – 3 bar abs
3 – 45 psi abs

FMD 510-16

Inlet pressure: 12 bar / 175 psi
Outlet pressure: 0.2 – 3 bar abs
3 – 45 psi abs

FMD 510-18

Inlet pressure: 12 bar / 175 psi
Outlet pressure: 0.2 – 3 bar abs
3 – 45 psi abs

FMD 510-26/-27

Inlet pressure: 12 bar / 175 psi
Outlet pressure: 0.2 – 3 bar abs
3 – 45 psi abs

FMD 540-14

Inlet pressure: 12 bar / 175 psi
Outlet pressure: 0.2 – 2 bar
3 – 30 psi

FMD 540-16

Inlet pressure: 12 bar / 175 psi
Outlet pressure: 0.2 – 2 bar
3 – 30 psi

FMD 540-18

Inlet pressure: 12 bar / 175 psi
Outlet pressure: 0.2 – 2 bar
3 – 30 psi

FMD 540-26/-27

Inlet pressure: 12 bar / 175 psi
Outlet pressure: 0.2 – 2 bar
3 – 30 psi

DUAL-STAGE - 200 BAR

FMD 502-14

Inlet pressure: 230 bar / 3300 psi
Outlet pressure: 3, 6, 10.5 bar
45, 85, 150 psi

FMD 502-16

Inlet pressure: 230 bar / 3300 psi
Outlet pressure: 3, 6, 10.5 bar
45, 85, 150 psi

FMD 502-18

Inlet pressure: 230 bar / 3300 psi
Outlet pressure: 3, 6, 10.5 bar
45, 85, 150 psi

FMD 502-26/-27

Inlet pressure: 230 bar / 3300 psi
Outlet pressure: 3, 6, 10.5 bar
45, 85, 150 psi

FMD 522-14

Inlet pressure: 230 bar / 3300 psi
Outlet pressure: 0.2 – 3 bar abs
3 – 45 psi abs

FMD 522-16

Inlet pressure: 230 bar / 3300 psi
Outlet pressure: 0.2 – 3 bar abs
3 – 45 psi abs

FMD 522-18

Inlet pressure: 230 bar / 3300 psi
Outlet pressure: 0.2 – 3 bar abs
3 – 45 psi abs

FMD 522-27

Inlet pressure: 230 bar / 3300 psi
Outlet pressure: 0.2 to 3 bar abs
3 – 45 psi abs

FMD 562-14

Inlet pressure: 230 bar / 3300 psi
Outlet pressure: 0.2 – 2 bar
3 – 30 psi

FMD 562-16

Inlet pressure: 230 bar / 3300 psi
Outlet pressure: 0.2 – 2 bar
3 – 30 psi

FMD 562-18

Inlet pressure: 230 bar / 3300 psi
Outlet pressure: 0.2 – 2 bar
3 – 30 psi

FMD 562-27

Inlet pressure: 230 bar / 3300 psi
Outlet pressure: 0.2 – 2 bar
3 – 30 psi

SINGLE-STAGE - 300 BAR

FMD 530-14

Inlet pressure: 315 bar / 4500 psi
Outlet pressure: 6, 14, 28, 50, 200 bar
85, 200, 400, 720, 2900 psi

FMD 530-16

Inlet pressure: 315 bar / 4500 psi
Outlet pressure: 6, 14, 28, 50 bar
85, 200, 400, 720 psi

FMD 530-18

Inlet pressure: 315 bar / 4500 psi
Outlet pressure: 6, 14, 28, 50 bar
85, 200, 400, 720 psi

FMD 530-26/-27

Inlet pressure: 315 bar / 4500 psi
Outlet pressure: 6, 14, 28, 50 bar
85, 200, 400, 720 psi

DUAL-STAGE - 300 BAR

FMD 532-14

Inlet pressure: 315 bar / 4500 psi
Outlet pressure: 3, 6, 10.5 bar
45, 85, 150 psi

FMD 532-16

Inlet pressure: 315 bar / 4500 psi
Outlet pressure: 3, 6, 10.5 bar
45, 85, 150 psi

FMD 532-18

Inlet pressure: 315 bar / 4500 psi
Outlet pressure: 3, 6, 10.5 bar
45, 85, 150 psi

FMD 532-26/-27

Inlet pressure: 315 bar / 4500 psi
Outlet pressure: 3, 6, 10.5 bar
45, 85, 150 psi

GAS SUPPLY PANELS, SERIES 500 AND ACETYLENE

SMD 500/532-16

Single-stage
Brass or stainless steel
Inlet pressure: 230 /315 bar
3300/4500 psi
Outlet pressure: 14, 28, 50, 200 bar
/ 200, 400, 720, 2900 psi



SMD 502/532-16

Dual-stage
Brass or stainless steel
Inlet pressure: 230 /315 bar
3300/4500 psi
Outlet pressure: 3, 6, 10.5 bar
45, 85, 150 psi



SMD 500/532-24

Single-stage
Brass or stainless steel
Inlet pressure: 230 /315 bar
3300/4500 psi
Outlet pressure: 14, 28, 50, 200 bar
/ 200, 400, 720, 2900 psi

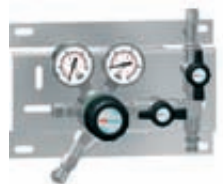

SMD 500/532-25

Single-stage
Brass or stainless steel
Inlet pressure: 230 /315 bar
3300/4500 psi
Outlet pressure: 14, 28, 50, 200 bar
/ 200, 400, 720, 2900 psi



SMD 500/532-27

Single-stage, with inert gas purging
Stainless steel
Inlet pressure: 230 /315 bar
3300/4500 psi
Outlet pressure: 14, 28, 50, 200 bar
/ 200, 400, 720, 2900 psi



SMD 502/532-24

Dual-stage
Brass or stainless steel
Inlet pressure: 230 /315 bar
3300/4500 psi
Outlet pressure: 3, 6, 10.5 bar
45, 85, 150 psi



SMD 502/532-27

Dual-stage, with inert gas purging
Stainless steel
Inlet pressure: 230 /315 bar
3300/4500 psi
Outlet pressure: 3, 6, 10.5 bar
45, 85, 150 psi



BMD 500/532-30

Single-stage, max. 2x4 cylinders
Brass or stainless steel
Inlet pressure: 230 /315 bar
3300/4500 psi
Outlet pressure: 14, 28, 50, 200 bar
200, 400, 725, 2900 psi



BMD 500/532-32

Single-stage, max. 2x4 cylinders
Brass or stainless steel
Inlet pressure: 230 /315 bar
3300/4500 psi
Outlet pressure: 14, 28, 50, 200 bar
/ 200, 400, 720, 2900 psi



BMD 500/532-34

Single-stage, max. 2x5 cylinders
With inert gas purging
Brass or stainless steel
Inlet pressure: 230 /315 bar
3300/4500 psi
Outlet pressure: 14, 50 bar
/ 200, 720 psi



BMD 500/532-35

Single-stage, max 2x5 cylinders
With process gas purging
Brass or stainless steel
Inlet pressure: 230 /315 bar
3300/4500 psi
Outlet pressure: 14, 50 bar
/ 200, 720 psi



BMD 500/532-39

Single-stage, max. 2x5 cylinders
Brass or stainless steel
Inlet pressure: 230 /315 bar
3300/4500 psi
Outlet pressure: 14, 50 bar
/ 200, 720 psi



BMD 502/532-34

Dual-stage, max. 2x5 cylinders
With inert gas purging
Brass or stainless steel
Inlet pressure: 230 /315 bar
3300/4500 psi
Outlet pressure: 3, 6, 10 bar
/ 45, 85, 145 psi



BMD 502/532-35

Dual-stage, max. 2x5 Cylinder
With process gas purging
Brass or stainless steel
Inlet pressure: 230 /315 bar
3300/4500 psi
Outlet pressure: 3, 6, 10 bar
/ 45, 85/ 145psi

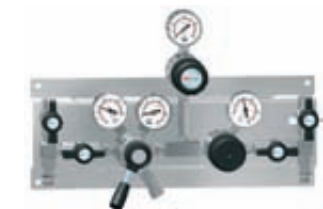

BMD 502/532-39

Dual-stage, max. 2x5 cylinders
Without purging
Brass or stainless steel
Inlet pressure: 230 /315 bar
3300/4500 psi
Outlet pressure: 3, 6, 10 bar
/ 45, 85, 145 psi



BMD 200-29

Single-stage,
For Acetylene
Brass
Outlet pressure: 1.5 bar / 22 psi



SMD 200-29

Single-stage,
For Acetylene
Brass
Outlet pressure: 1.5 bar / 22 psi



BMD 202-39

dual-stage,
For Acetylene
Brass
Outlet pressure: 1.5 bar / 22 psi



LINE PRESSURE REGULATORS SERIES 500

LMD 500-01/-03/-04/-05

Single-stage
Brass or stainless steel
Inlet pressure: 230 bar / 3300 psi
Outlet pressure:
0.2 - 3 / 0.5 - 6 / 1 - 14 bar
3 - 45 / 7.5 - 85 / 36 - 725 psi

LMD 510-01/-03/-04/-05

Single-stage
Brass or stainless steel
Inlet pressure: 12 bar / 175 psi
Outlet pressure:
0.2 - 2 / 0.2 - 3 bar abs.
3 - 22 / 3 - 45 psi abs.

LMD 530-01/-03/-04/-05

Single-stage
Brass or stainless steel
Inlet pressure: 315 bar / 4500 psi
Outlet pressure:
0.2 - 3 / 0.5 - 6 / 1 - 10.5 bar
3 - 45 / 7.5 - 85 / 14 - 150 psi

LMD 545-01/-03

Single-stage
Brass or stainless steel
Inlet pressure: 40 / 12 bar
- 580 / 175 psi
Outlet pressure: 0.20 / 1.3 bar
- 3 / 19 psi
40 bar Type: 0.5 / 3.0 bar
- 7 / 45 psi

LMD 500-PA

Single-stage, remote control
Brass or stainless steel
Inlet pressure: 200, 40, 20 bar /
2900, 580, 290 psi
Outlet pressure: 0.5 - 6 bar/
7.5 - 85 psi

LMD 502-03/-05

Dual-stage
Brass or stainless steel
Inlet pressure: 230 bar / 3300 psi
Outlet pressure:
0.2 - 3 / 0.5 - 6 / 1 - 10.5 bar
3 - 45 / 7.5 - 85 / 14 - 150 psi

LMD 522-03/-05

Dual-stage
Brass or stainless steel
Inlet pressure: 230 bar / 3300 psi
Outlet pressure:
0.2 - 2 / 0.2 - 3 bar abs.
3 - 22 / 3 - 45 psi abs.

LMD 532-03/-05

Dual-stage
Brass or stainless steel
Inlet pressure: 315 bar / 4500 psi
Outlet pressure:
0.2 - 1 / 0.5 - 3 / 0.5 - 6 / 1 - 10.5 bar
3 - 15 / 3 - 45 / 7 - 85 / 15 - 150 psi



LMD 545-01
4-Port-Type

LMD 545-03
6-Port-Type



Single-stage
Type-01

Single-stage
Type-04

Dual-stage
Type-03

Dual-stage
Type-05



Single-stage
Type-03

Single-stage
Type-05

POINT-OF-USE REGULATORS SERIES 500

EMD 500-06

Single-stage
Brass or stainless steel
Inlet pressure: 40 bar / 600 psi
Outlet pressure:
0.2 - 1.5 / 0.2 - 6 / 0.5 - 10.5 bar
3 - 22 / 3 - 85 / 7 - 150 psi

EMD 510-06

Single-stage
Brass or stainless steel
Inlet pressure: 12 bar / 175 psi
Outlet pressure:
0.2 - 2 / 0.2 - 3 bar abs.
3 - 22 / 3 - 45 psi abs.



LABORATORY GAS SUPPLY

Point-of-use regulators EMD 3100

Single-stage
Brass or stainless steel
Inlet pressure: 40 bar / 600 psi
Outlet pressure:
0.2 - 1.5 / 0.2 - 4 / 0.5 - 10.5 bar
3 - 22 / 3 - 60 / 7 - 150 psi
Analysis Version:
Inlet pressure: 10 bar / 145 psi
Outlet pressure: 2.2/4.4 bar - 33/66 psi



Basic body



Plate mounted



Wall assembly with
wall adaptor



Wall assembly



Bench version



Hanging version

EMD 3000



EMD 400



VALVE OVERVIEW

Diaphragm shut-off valve

MVA 500/530

Model: In-line
 Material: Brass chrome-plated /
 Stainless steel
 Upstream pressure: 230 / 315 bar
 3300 / 4500 psi
 Nominal width: DN5 - Kv-Value: 0.25
 Inlet/Outlet: NPT 1/4"

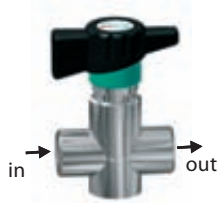

Diaphragm shut-off valve

MVA 400 G

Model: Straight
 Material: Brass chrome-plated /
 Stainless steel
 Upstream pressure: 40 bar / 600 psi
 Nominal width: DN5 - Kv-Value: 0.2
 Inlet/Outlet:
 G3/8" f - G3/8" m



Diaphragm regulating valve

MVR-A 500 G

Model: In-line
 Material: Brass chrome-plated /
 Stainless steel
 Upstream pressure: 40 bar (O2) / 50 bar
 600 / 725 psi
 Nominal width: DN2 - Kv-Value: 0.02
 Inlet/Outlet: NPT 1/4"

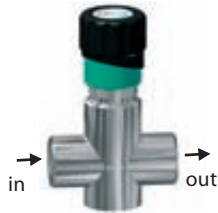

Diaphragm shut-off valve

MVA 400 W

Model: Elbow design
 Material: Brass chrome-plated /
 Stainless steel
 Upstream pressure: 40 bar / 600 psi
 Nominal width: DN5 - Kv-Value: 0.25
 Inlet/Outlet: G1/4" f - G3/8" m

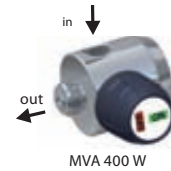

Diaphragm shut-off valve

MVA 501 G

Model: In-line
 Material: Brass / Brass chrome-plated /
 Stainless steel
 Upstream pressure: 40 bar (O2) / 50 bar
 600 (O2) / 725 psi
 Nominal width: DN8 - Kv-Value: 0.5
 Inlet: NPT 1/4" f or G3/8" f
 Outlet: NPT 1/4" f or G3/8" f

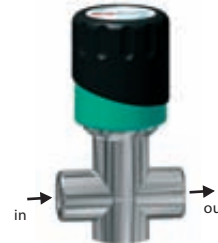

Diaphragm regulating valve

MVR-A 400 W

Model: Elbow design
 Material: Brass chrome-plated /
 Stainless steel
 Upstream pressure: 40 bar / 600 psi
 Nominal width: DN2 - Kv-Value: 0.2
 Inlet - outlet: G1/4" m - G1/4" f



Packed regulating valve

FAV 115

Model: Elbow design
 Material: Stainless steel
 Upstream pressure: 230 bar / 2900 psi
 Nominal width: DN2
 Inlet: cylinder connector DIN 477
 Outlet: tube fitting 6mm or hose
 nozzle 8 mm

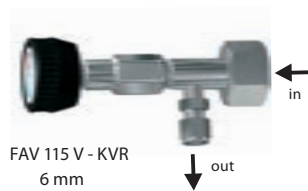

Diaphragm regulating valve

MVR-A 400 G

Model: Straight
 Material: Brass chrome-plated /
 Stainless steel
 Upstream pressure: 40 bar / 600 psi
 Nominal width: DN2 - Kv-Value: 0.2
 Inlet - outlet: G1/4" f - G1/4" f



Cylinder connection valve

FAV 500-36

Model: Elbow design
 Material: Brass chrome-plated /
 Stainless steel
 Upstream pressure: 50 bar / 725 psi
 Nominal width: DN2 - Kv-Value: 0.02
 Inlet: cylinder connector DIN 477
 Outlet: tube fitting 6mm

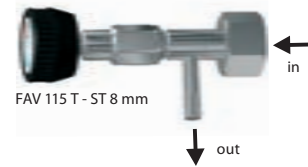

Cylinder connection valve

FAV 500-37

with gauge
 Model: Elbow design
 Material: Brass chrome-plated /
 Stainless steel
 Upstream pressure: 50 bar / 725 psi
 Nominal width: DN2 - Kv-Value: 0.02
 Inlet: cylinder connector DIN 477

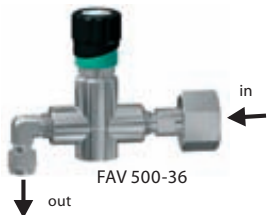
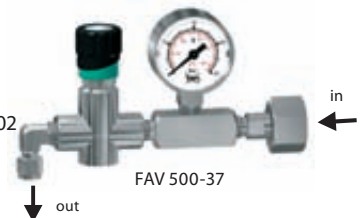

HIGH PURITY REGULATORS SERIES 500

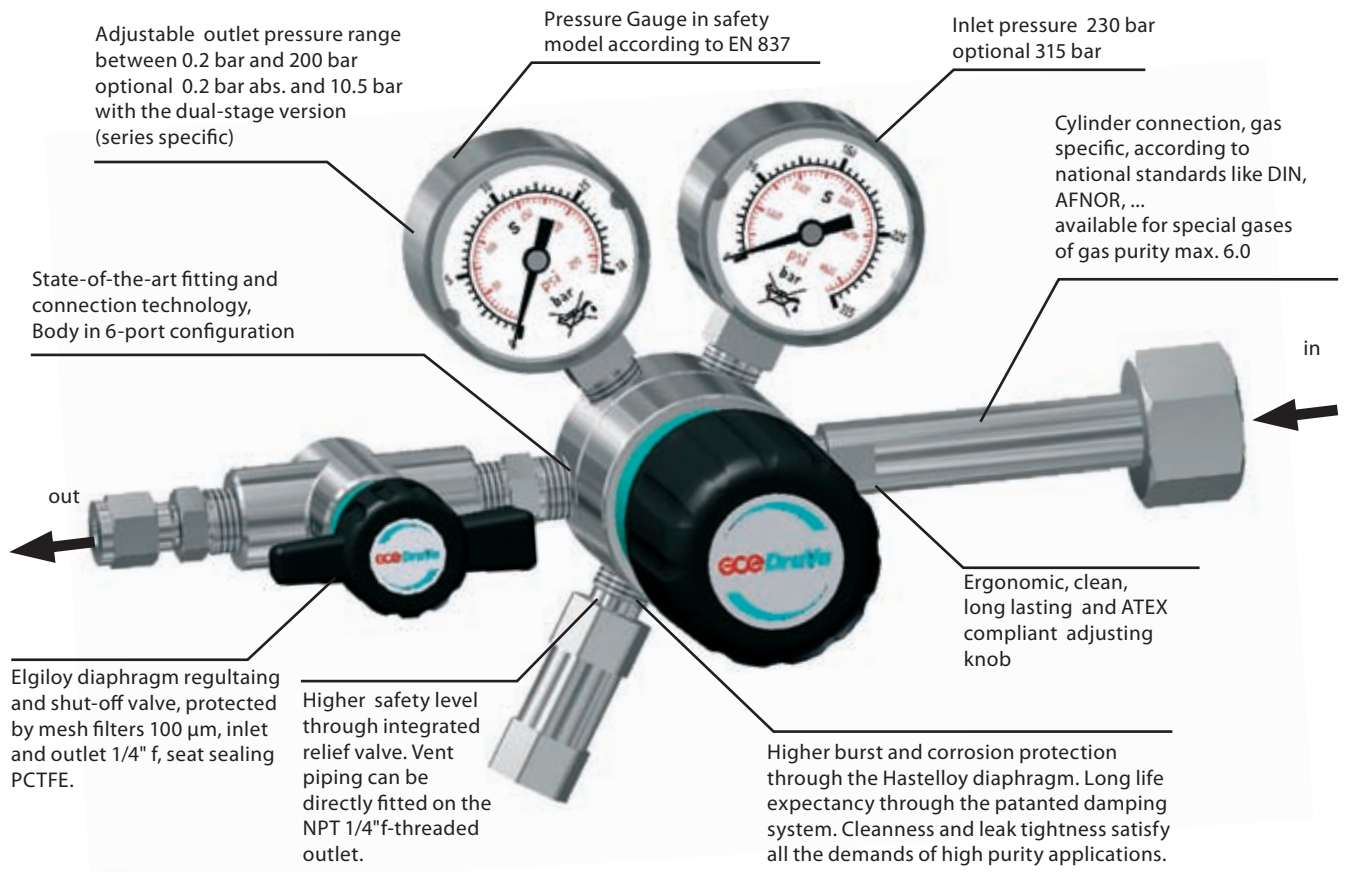

CONNECTIONS 6-PORT-VERSION (FRONTAL VIEW)

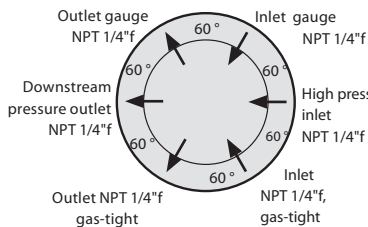

CONNECTIONS 4-PORT-VERSION (FRONTAL VIEW)

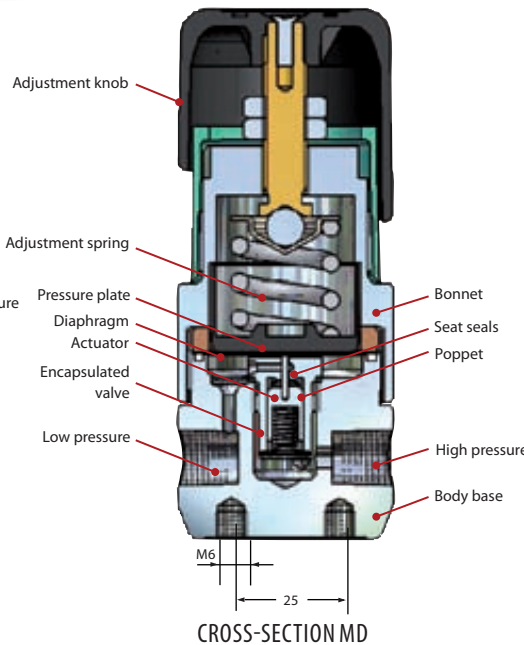
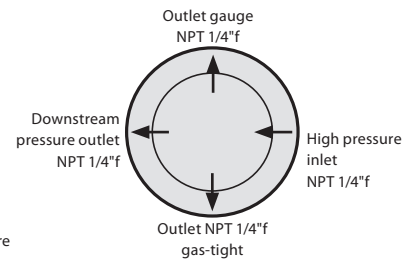

SERIES SPECIFIC DATA*

BODY MATERIAL

Stainless steel 316L (1.4404) specially cleaned and electro-polished or brass CW614 (CuZn39Pb3) specially cleaned, nickel-plated and chrome-plated.

SEAL MATERIAL

PCTFE, FKM, EPDM, etc., dependant on gas specification and purity requirements. Material is specified in "Technical data".

INNER PARTS

Pressure regulator unit with integrated mesh

filter from 10 µm mesh opening at inlet and 100 µm at outlet.

DIAPHRAGM

Good protection against burst and corrosion due to diaphragm material Hastelloy.

PERFORMANCE DATA

See chart chapter at the end of this catalog, for different performance data please contact GCEdruVa.

GUARANTEED LEAKAGE RATES

< 1×10⁻⁹ mbar l/s Helium (body).
< 1×10⁻⁶ mbar l/s Helium (seat).

WORKING TEMPERATURES

-25 °C to +70 °C / -13 °F to 158 °F

PURITY

≤ 6.0

CYLINDER / INLET CONNECTIONS

Compliant with German national standard: DIN 477. Other connections such as US-Norm CGA, British Standard BS etc. are available upon request.

*Differing data of specific components of the series 500 are listed in product "Technical data".

CYLINDER PRESSURE REGULATORS FMD 500-14/-16/-18



**Single-stage,
for inert, reactive, flammable and oxidizing gases and gas mixtures,
purity max. 6.0,
cylinder pressure 230 bar / 3300 psi,
downstream pressure range 0.5 - 200 bar / 3 - 2900 psi**

SPECIAL FEATURES

- Diaphragm valve with 90° shut-off function (FMD 500-16) or regulating valve (FMD 500-18)
- Diaphragm pressure regulator
- ATEX compliant adjustment knobs

DESCRIPTION

These pressure regulators consists of a cylinder connection, pressure regulator body, upstream and downstream pressure gauges, diaphragm shut-off valve (type-16) regulating valve (type-18), relief valve (by downstream pressure >50bar RV on request) and outlet tube fittings. The use of contact gauge (accessories) in conjunction with alarm box (accessories) facilitates the monitoring of gas reserves.

APPLICATION

The cylinder pressure regulator series FMD 500 offers a wide range of uses and great performance. The FMD 500-14 is the basic model. The FMD 500-16 allows shut-off of the gas flow while maintaining the pressure regulator's adjustment. The regulating valve of the FMD 500-18 allows a finer apportioning of gas flow.



FLOW SCHEMATIC

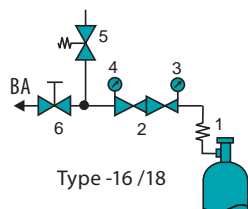
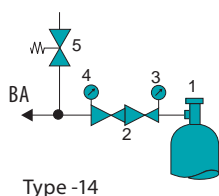

- 1 Cylinder connection
 - 2 Pressure regulator
 - 3 Upstream pressure gauge
 - 4 Downstream pressure gauge
 - 5 Relief valve
 - 6 Downstream shut-off valve (Type -16)
/ regulating valve (Type -18)
- BA Process gas outlet

TECHNICAL DATA

Body:	stainless steel 316L (1.4404) specially cleaned and electro-polished or brass CW614 (CuZn39Pb3) specially cleaned, nickel-plated and chrome-plated
Seat seals:	PCTFE
Seal material:	PCTFE (SS), PVDF (brass)
Relief valve:	outlet NPT1/4" f, by downstream pressure >50bar RV*
Relief valve seat seal:	SS: FKM, (EPDM, FFKM)*, MS: EPDM, (FKM)*
Pressure gauge range:	-1 - 10 bar (-15 - 145 psi) 0 - 25 bar (0 - 365 psi) 0 - 40 bar (0 - 600 psi) 0 - 80 bar (0 - 1150 psi) 0 - 315 bar (0 - 4500 psi)
Performance data:	see chapter 5
Basic design aspects:	see page 13
Weight:	approx. 1.5 kg (type -14), 1.8 kg (type -16/18)
Dimensions (wxhxd):	approx. 225x 140x 125mm
Cylinder connections:	according to gas type, see chapter 5
Outlet:	NPT 1/4" f, optional tube fitting

* on request

ORDER CODE

Type	Material	Upstream pressure	Downstream pressure	Inlet	Outlet	Contact gauge	Gas type
FMD 500-14	BC	F	6	DIN	CL6	Ki	GAS
FMD 500-14	BC = brass	F = 230 bar/3300 psi	6 = 0.5 - 6 bar / 3 - 85 psi	DIN	0=NPT 1/4" f	0 = without	Please
FMD 500-16	chrome-plated		14 = 1 - 14 bar / 15 - 200 psi	ANSI	CL6**	Ki = with	specify
FMD 500-18	SS = stainless steel		28 = 2.5 - 28 bar / 35 - 365 psi	AFNOR	CL8		
			50 = 2.5 - 50 bar / 35 - 720 psi	NBN	CL 1/8"		
			200 = 10 - 200 bar / 145 - 2900 psi	BS 341	CL 1/4"		
			(200 bar not with FMD 500-18)	CGA	NO6		
				NEN, UNI			

CYLINDER PRESSURE REGULATORS FMD 502-14/-16/-18

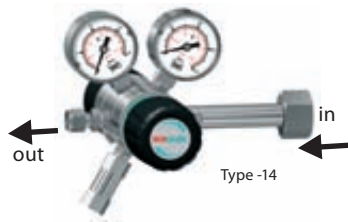

**Dual-stage,
for inert, reactive, flammable and oxidizing gases and gas mixtures,
purity max. 6.0
cylinder pressure 230 bar / 3300 psi
downstream pressure range 0.2 - 10.5 bar / 3 - 145 psi**

SPECIAL FEATURES

- Outlet pressure virtually independent of inlet pressure due to dual-stage design
- Diaphragm valve with 90°-shut-off function (FMD 502-16) or regulating valve (FMD 502-18)
- Diaphragm pressure regulator
- ATEX compliant adjustment knobs

DESCRIPTION

These pressure regulators consists of a cylinder connection, pressure regulator body, upstream and downstream pressure gauges, relief valve, diaphragm shut-off valve (type -16) diaphragm regulating valve (type -18) and outlet tube fittings. The use of contact gauge (accessories) in conjunction with alarm box (accessories) facilitates the monitoring of gas reserves.

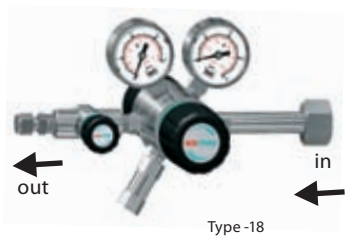
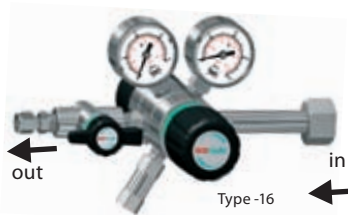

APPLICATION

The cylinder pressure regulator series FMD 502 offers a wide range of uses and great performance. The FMD 502-16 allows shut-off/opening of the gas flow while maintaining the pressure regulator's adjustment. The FMD 502-18 allows for pressure setting as well as a finer apportioning of gas flow. The dual-stage design ensures the uniformity of the downstream pressure irrespectively of the level of the cylinder pressure.

TECHNICAL DATA

Body:	stainless steel 316L (1.4404) specially cleaned and electro-polished or brass
	CW614 (CuZn39Pb3) specially cleaned, nickel-plated and chrome-plated
Seat seals 1st stage:	PCTFE
Seat seals 2nd stage:	PTFE
Seal material:	PCTFE (SS), PTFE (brass)
Relief valve seat seals:	Stainless steel: FKM, (EPDM, FFKM) *
	Brass: EPDM, (FKM)*
Performance data:	see chapter 5
Basic design aspects:	see page 13
Pressure gauge range:	-1 - 5 bar (-15 - 75 psi)
	-1 - 10 bar (-15 - 145 psi)
	-1 - 18 bar (-15 - 260 psi)
	0 - 315 bar (0 - 4500 psi)
Weight:	approx. 2.1 kg (type -14), 2.4 kg (type -16/18)
Dimensions (w×h×d):	approx. 225×140×210 mm
Cylinder connections:	in compliance with DIN 477
Cylinder connections:	according to gas type, see chapter 5
Outlet:	NPT 1/4"f, optional tube fitting

*on request

FLOW SCHEMATIC

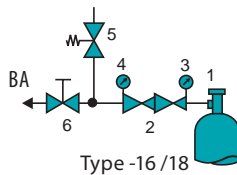
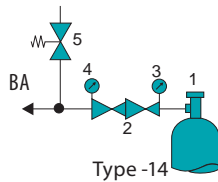

- 1 Cylinder connection
 - 2 Pressure regulator
 - 3 Upstream pressure gauge
 - 4 Downstream pressure gauge
 - 5 Relief valve
 - 6 Downstream shut-off valve (type -16)
/ regulating valve (type -18)
- BA Process gas outlet

ORDER CODE

Type	Material	Upstream pressure	Downstream pressure	Inlet	Outlet	Contact gauge	Gas type
FMD 502-14	BC	F	3	DIN	CL6	Ki	GAS
FMD 502-14	BC = brass	F = 230 bar/3300 psi	1 = 0.2 - 1 bar / 3 - 15 psi	DIN	0=NPT 1/4"f	0 = without	Please
FMD 502-16	chrome-plated		3 = 0.2 - 3 bar / 3 - 45 psi	ANSI	CL6**	Ki = with	specify
FMD 502-18	SS = stainless steel		6 = 0.5 - 6 bar / 3 - 85 psi	AFNOR	CL8		
			10 = 1 - 10.5 bar / 7 - 150 psi	NBN	CL 1/8"		
				BS 341	CL 1/4"		
				CGA	NO6		
				NEN			
				UNI			

CYLINDER PRESSURE REGULATORS FMD 500-26/27



**Single-stage,
with inert gas purging,
for reactive, flammable, oxidizing and corrosive gases and gas mixtures,
not for oxygen,
purity max. 6.0,
cylinder pressure 230 bar
downstream pressure range 0.5 - 200 bar / 7 - 2900 psi**

SPECIAL FEATURES

- Diaphragm shut-off valve
- Diaphragm pressure regulator
- ATEX compliant adjustment knobs
- Optionally with sub-atmospheric pressure regulation (FMD 510)
- Optional gas-tight welded connections for optimum purge conditions and maximum safety

DESCRIPTION

These pressure regulators consists of a cylinder connection, purge valve block with a check valve, purge inlet and outlet valve, pressure regulator body, upstream and downstream pressure gauges, relief valve (by downstream pressure >50bar RV on request), and outlet tube fittings, (FMD 500-27 with diaphragm shut-off valve MVA 500 G). Optionally the pressure regulator, purge valve block and cylinder connection can be joined with one another using orbital welding for a gas-tight connection. The use of contact gauge (accessories) in conjunction with alarm box (accessories) facilitates the monitoring of gas reserves.

APPLICATION

The cylinder pressure regulator series FMD 500 stands out for its wide range of uses and excellent performance. The upstream purge valve block allow as an external gas purging with inert gas. The purge volume is kept to a minimum (only cylinder connection) and the purge gases can be separately conveyed. Therefore this regulator is especially suited to use with reactive, flammable, oxidizing and corrosive gases. It guarantees optimum purge conditions and with toxic gases maximum safety for the application and for the operator.

FLOW SCHEMATIC

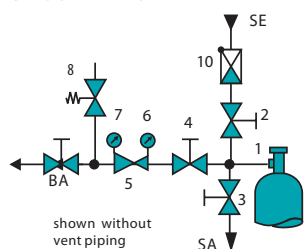

FLOW SCHEMATIC

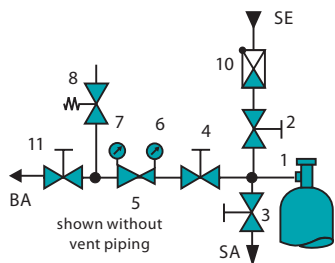

TECHNICAL DATA

Body:	stainless steel 316L (1.4404) specially cleaned and electro-polished
Seals:	PCTFE
Relief valve seat seals:	FKM, (EPDM, FFKM) *
Pressure gauge range:	-1 - 10 bar / 0 - 25 bar / 0 - 40 bar / 0 - 80 bar / 0 - 315 bar
Weight:	approx. 2.9 kg (type -26), 3.3 kg (type -27)
Dimensions (wxhxd):	approx. 310x180x125 mm
Performance data:	see chapter 5
Basic design aspects:	see page 13
Purge inlet:	check valve, tube fitting 6 mm
Purge outlet:	NPT 1/4" f, optional tube fitting
Cylinder connections:	according to gas type, see chapter 5
Outlet:	NPT 1/4" f, optional tube fitting

* on request

- 1 Cylinder connection
- 2 Purge inlet valve
- 3 Purge outlet valve
- 4 Upstream shut-off valve
- 5 Cylinder pressure regulator
- 6 Upstream pressure gauge
- 7 Downstream pressure gauge
- 8 Relief valve
- 10 Check valve
- 11 Downstream shut-off valve (only type -27)
- BA Process gas outlet
- SE Purge inlet
- SA Purge outlet

ORDER CODE

Type	Material	Upstream pressure	Downstream pressure	Inlet	Outlet	Contact gauge	Vent piping	Gas type
FMD 500-26	SS	F	6	DIN	CL6	Ki	A	GAS
FMD 500-26	SS = stainless steel	F = 230 bar	6 = 0.5 - 6 bar	DIN	0=NPT 1/4" f	0 = without	0 = without	Please specify
FMD 500-27	steel		14 = 1 - 14 bar	ANSI	CL3**	Ki = with	A = with	(no O2)
			28 = 2.5 - 28 bar	AFNOR	CL6(Standard)		(Only in	
			50 = 2.5 - 50 bar	NBN	CL8		conjunction	
			200 = 10 - 200 bar	BS 341	CL 1/8"		with RV)	
				CGA	CL 1/4"			
				NEN, UNI				

CYLINDER PRESSURE REGULATORS FMD 502-26/-27



Type -26



Type -27

Dual-stage, with external gas purging, for inert, reactive, flammable and oxidizing gases and gas mixtures, not for oxygen, purity max. 6.0, cylinder pressure 230 bar / 3300 psi, downstream pressure range 0.2 - 6 bar / 3 - 85 psi

SPECIAL FEATURES

- With inert gas purging
- Optimum purge conditions with purge valve block
- Downstream pressure virtually independent of upstream pressure due to dual-stage design
- With diaphragm shut-off valve
- Diaphragm pressure regulator
- ATEX compliant adjustment knobs

DESCRIPTION

These pressure regulators consists of a cylinder connection, purge valve block with a check valve, purge inlet and outlet valve, pressure regulator body, upstream and downstream pressure gauges, diaphragm relief valve MVA 500 (only type -27), relief valve, and outlet tube fittings. Optionally the pressure regulator, purge valve block and cylinder connection can be joined with one another using orbital welding for a gas-tight connection. The use of contact gauge (accessories) in conjunction with alarm box (accessories) facilitates the monitoring of gas reserves.

FLOW SCHEMATIC

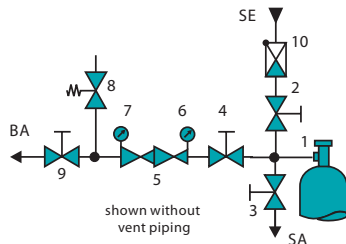

- 1 Cylinder connection
 - 2 Purge inlet valve
 - 3 Purge outlet valve
 - 4 Upstream shut-off valve
 - 5 Cylinder pressure regulator
 - 6 Upstream pressure gauge
 - 7 Downstream pressure gauge
 - 8 Relief valve
 - 9 Downstream shut-off valve (only type -27)
 - 10 Check valve
- BA Process gas outlet
SE Purge inlet
SA Purge outlet

APPLICATION

The pressure regulator series FMD 500 stands out for its wide range of uses and excellent performance. The dual-stage design ensures the uniformity of the downstream pressure irrespectively of the level of the cylinder pressure. The upstream purge valve block allow as an external gas purging with inert gas. The purge volume is kept to a minimum (only cylinder connection) and the purge gases can be separately conveyed. Therefore this regulator is especially suited to use with reactive, flammable, oxidizing and corrosive gases. It guarantees optimum purge conditions and with toxic gases maximum safety for the application and for the operator.

TECHNICAL DATA

Body:	stainless steel 316L (1.4404) specially cleaned and electro-polished
Seat seals 1st stage:	PCTFE
Seat seals 2nd stage:	PTFE
Body seals:	PCTFE
Relief valve seat seals:	FKM, (EPDM, FFKM)*
Performance data:	see chapter 5
Basic design aspects:	see page 13
Pressure gauge range:	-1 - 5 bar (-15 - 75 psi)
	-1 - 10 bar (-15 - 145 psi)
	0 - 315 bar (0 - 4500 psi)
Weight:	approx. 3.5 kg (type -26), 3.9 kg (type -27)
Dimensions (w×h×d):	approx. 310×180×230 mm
Purge inlet:	check valve, tube fitting 6 mm
Purge outlet:	NPT 1/4"f, optional tube fitting
Cylinder connections:	according to gas type, see chapter 5
Outlet:	NPT 1/4"f, optional tube fitting

* on request

ORDER CODE

Type	Material	Upstream pressure	Downstream pressure	Inlet	Outlet	Contact gauge	Vent piping	Gas type
FMD 502-26	SS	F	3	DIN	CL6	Ki	A	GAS
FMD 502-26	SS = stainless steel	F = 230 bar / 3300 psi	3 = 0.2 - 3 bar / 3 - 45 psi	DIN	0=NPT 1/4"f	0 = without	0 = without	Please specify (no O2)
FMD 502-27	steel		6 = 0.5 - 6 bar / 3 - 85 psi	ANSI AFNOR NBN BS 341 CGA NEN, UNI	CL3** CL6 (standard) CL8 CL 1/8"	Ki = with	A = with (Only in conjunction with RV)	

CYLINDER PRESSURE REGULATORS FMD 510/540-14/-16/-18

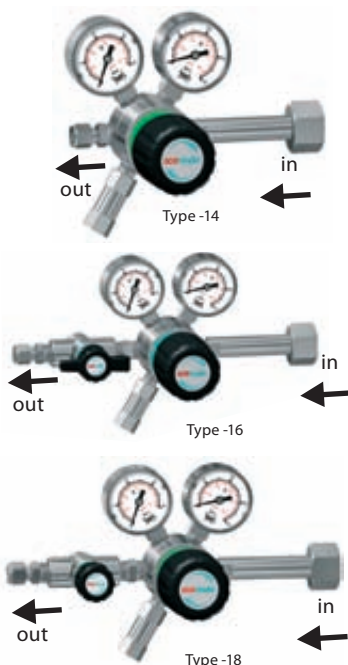

**Single-stage,
for inert, reactive, flammable and oxidizing gases and gas mixtures,
purity max. 6.0
cylinder pressure 12 bar / 175 psi,
FMD 510: downstream pressure range 0.2 - 3 bar abs / 3 - 45 psi abs,
FMD 540: downstream pressure range 0.2 - 2 bar / 3 - 30 psi**

SPECIAL FEATURES

- For low downstream pressure
- Subatmospheric-pressure regulation (FMD 510)
- Diaphragm valve with 90°-shut-off function (FMD Type -16) or regulating valve (FMD Type -18)
- Diaphragm regulator
- ATEX compliant adjustment knobs

DESCRIPTION

These pressure regulators consists of a cylinder connection, pressure regulator body, upstream and downstream pressure gauges, diaphragm shut-off valve MVA 500 (type -16), regulating valve MVR 500 (type -18), relief valve and outlet tube fittings. The use of contact gauge (accessories) in conjunction with alarm box (accessories) facilitates the monitoring of gas reserves.

APPLICATION

The pressure regulator series FMD 510/540 reduces low upstream pressure to a very low downstream pressure : FMD 510 down to 0.2 bar absolut and is suitable for Subatmospheric-pressure regulation, the FMD 540 down to 0.2 bar. The FMD 510/540 would be selected depending on the requirements and needs of the downstream use, in regards of the shut-off or rather regulating of the gas stream and Subatmospheric-pressure regulation.

FLOW SCHEMATIC

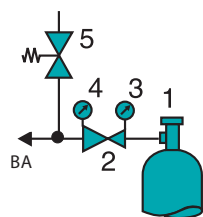

Type -14

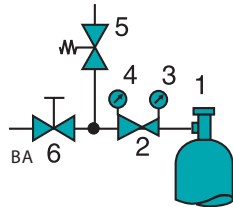

Type -16 /18

- 1 Cylinder connection
 - 2 Pressure regulator
 - 3 Upstream pressure gauge
 - 4 Downstream pressure gauge
 - 5 Relief valve
 - 6 Downstream shut-off valve (type -16)
/ regulating valve (type -18)
- BA Process gas outlet

TECHNICAL DATA

Body:	Stainless steel 316L (1.4404) specially cleaned and electro-polished or brass 2.0401.26 specially cleaned, nickel-plated and chrome-plated
Seat seals:	Stainless steel: FFKM, (EPDM)*
Brass:	EPDM, (FKM)*
Seal material:	PCTFE (stainless steel), PVDF (brass)
Relief valve seat seals:	Stainless steel: FKM, (EPDM, FFKM)* Brass: EPDM, (FKM)*
Performance data:	see chapter 5
Basic design aspects:	see page 13
Pressure gauge range:	-1 - 1.5 bar (-15 - 40 psi) -1 - 5 bar (-15 - 75 psi) -1 - 18 bar (-15 - 260 psi)
Optional:	0 - 600 mbar (0 - 8.5 psi) with diameter 63 mm
Weight:	approx. 1.5 kg (type -14), 1.8 kg (type -16/18)
Dimensions (wxhxd):	approx. 139x126x175 (-14), 223 (-16 and -18) mm
Cylinder connections:	according to gas type, see chapter 5
Outlet:	NPT 1/4" f, optional tube fitting

* on request

ORDER CODE

Type	Material	Upstream pressure	Downstream pressure	Inlet	Outlet	Contact gauge	Gas type
FMD 510-14	BC	D	2	DIN	CL6	Ki	GAS
FMD 510-14	BC = brass	D = 12 bar	FMD 510:	DIN	0=NPT 1/4" f	0 = without	Please
FMD 510-16	chrome-plated	/175 psi	2a = 0.2 - 2 bar abs. /3 - 30 psi abs.	ANSI	CL6**	Ki = with	specify
FMD 510-18	SS = stainless		3a = 0.2 - 3 bar abs. /3 - 45 psi	AFNOR	CL8		
FMD 540-14	steel		abs.	NBN	CL 1/8"		
FMD 540-16			FMD 540:	BS 341	CL 1/4"		
FMD 540-18			1 = 0.2 - 1 bar/3 - 15 psi	CGA	NO6		
			2 = 0.2 - 2 bar/3 - 30 psi	NEN			
				UNI			

CYLINDER PRESSURE REGULATORS FMD 510/540-26/-27

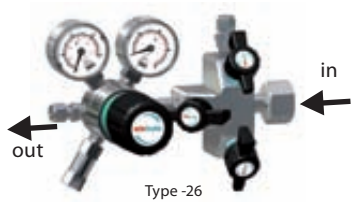

Type-26



Type-27

Single-stage, with inert gas purging, for inert, reactive, flammable and oxidizing gases and gas mixtures, purity max. 6.0, cylinder pressure 12 bar / 175 psi
FMD 510: downstream pressure range 0.2 - 3 bar abs / 3 - 45 psi abs
FMD 540: downstream pressure range 0.2 - 2 bar / 3 - 30 psi

SPECIAL FEATURES

- For low downstream pressure
- With external gas purging
- Subatmospheric-pressure regulation (FMD 510)
- With diaphragm shut-off valve
- Diaphragm regulator
- ATEX compliant adjustment knobs

DESCRIPTION

These pressure regulators consists of a cylinder connection , purge valve block with a check valve, purge inlet and outlet valve, pressure regulator body, upstream and downstream pressure gauges, diaphragm shut-off valve MVA 500 (only type-27), relief valve and outlet tube fittings. Optionally the pressure regulator, purge valve block and cylinder connection can be joined with one another using orbital welding for a gas-tight connection. The use of contact gauge (accessories) in conjunction with alarm box (accessories) facilitates the monitoring of gas reserves.

FLOW SCHEMATIC

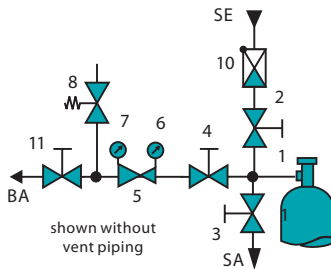

- 1 Cylinder connection
 2 Purge inlet valve
 3 Purge outlet valve
 4 Upstream shut-off valve
 5 Pressure regulator
 6 Upstream pressure gauge
 7 Downstream pressure gauge
 8 Relief valve
 10 Check valve
 11 Downstream shut-off valve (only type -27)
 BA Process gas outlet
 SE Purge inlet
 SA Purge outlet

APPLICATION

The pressure regulator series FMD 510/540 reduces low upstream pressure to a very low downstream pressure : FMD 510 down to 0.2 bar absolut and is suitable for Subatmospheric-pressure regulation, der FMD 540 down to 0.2 bar. The type of regulator is selected according to the requirements of the downstream uses with regards to the shut-off or rather regulating of the gas stream. The upstream purge valve block allows for an external gas purging with inert gas. The purge volume is kept to a minimum (only cylinder connection) and the purge gases can be separately conveyed. For this reason these regulators are especially suited for use with reactive, flammable, oxidizing and corrosive gases. It guarantees optimum purge conditions and with toxic gases maximum safety for the application and for the operator.

TECHNICAL DATA

Body:	stainless steel 316L (1.4404) specially cleaned and electro-polished
Seat seals:	FFKM, (EPDM *)
Seals:	PCTFE
Relief valve seat seals:	FKM, (EPDM, FFKM) *
Performance data:	see chapter 5
Basic design aspects:	see page 13
Pressure gauge range:	-1 - 1.5 bar (-15 - 40 psi) -1 - 5 bar (-15 -75 psi)/-1 - 18 bar (-15 - 260 psi)
Optional:	0 - 600 mbar (8.7 psi) with Ø 63 mm
Weight:	approx. 3.3kg (type-26), 3.7kg (type-27)
Dimensions (w×h×d):	approx. 310×180×230 mm
Purge inlet:	check valve, tube fitting 6 mm
Purge outlet:	NPT 1/4"f, optional tube fitting
Cylinder connections:	according to gas type, see chapter 5
Outlet:	NPT 1/4"f, optional tube fitting

* on request

ORDER CODE

Type	Material	Upstream pressure	Downstream pressure	Inlet	Outlet	Contact gauge	Vent piping	Gas type
FMD 510-26	SS	D	2	DIN	CL6	Ki	A	GAS
FMD 510-26	SS = stainless steel	D = 12 bar /175 psi	FMD 510: 2 a = 0.2 - 2 bar abs. /3 - 30 psi abs.	DIN	0=NPT 1/4"f	0 = without Ki = with	0 = without A = with (Only in conjunction with RV)	Please specify
FMD 540-26			3a = 0.2 - 3 bar abs. /3 - 45 psi abs.	AFNOR	CL 1/8"			
FMD 540-27			FMD 540: 1 = 0.2 - 1 bar / 3 - 15 psi 2 = 0.2 - 2 bar /3 - 30 psi	NBN BS 341 CGA NEN UNI				

CYLINDER PRESSURE REGULATORS FMD 522/562-14/-16/-18

**Dual-stage,
for inert, reactive, flammable and oxidizing gases and gas mixtures,
purity max. 6.0,
cylinder pressure 230 bar / 3300 psi,
FMD 522: downstream pressure range 0.2 - 3 bar abs / 3 - 45 psi abs,
FMD 562: downstream pressure range 0.2 - 2 bar / 3 - 30 psi**

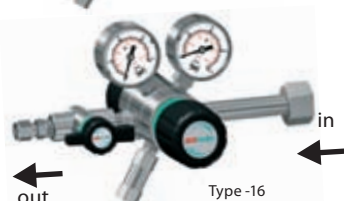
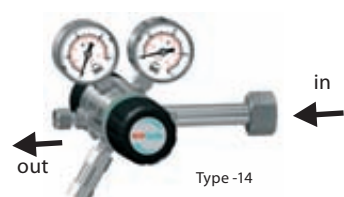

SPECIAL FEATURES

- For low downstream pressure
- Subatmospheric-pressure regulation (FMD 522)
- Downstream pressure is virtually independent of upstream pressure due to dual-stage design
- Diaphragm valve with 90°-shut-off function (type -16) or regulating valve (type -18)
- Diaphragm regulator
- ATEX compliant adjustment knobs

DESCRIPTION

These pressure regulators consists of a cylinder connection, pressure regulator body, upstream and downstream pressure gauges, diaphragm shut-off valve MVA 500 (only type-16), regulating valve MVR 500 (Type -18), relief valve and outlet tube fittings. The use of contact gauge (accessories) in conjunction with alarm box (accessories) facilitates the monitoring of gas reserves.

APPLICATION

The pressure regulator series FMD 522/562 reduces high upstream pressure to low downstream pressure : FMD 522 down to 0.2 bar absolute and is therefore suitable for subatmospheric-pressure regulation, the FMD 562 down to 0.2 bar. This type of regulator is selected according to the requirements of the downstream uses with regards to the shut-off or rather regulating of the gas stream.

FLOW SCHEMATIC

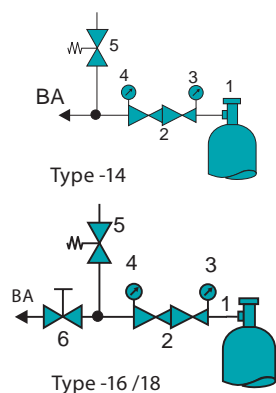

- 1 Cylinder connection
 - 2 Pressure regulator
 - 3 Upstream pressure gauge
 - 4 Downstream pressure gauge
 - 5 Relief valve
 - 6 Downstream shut-off valve (type -16) / regulating valve (type -18)
- BA Process gas outlet

TECHNICAL DATA

Body:	stainless steel 316L (1.4404) specially cleaned and electro-polished or brass CW614 (CuZn39Pb3) specially cleaned, nickel-plated and chrome-plated
Seat seals 1st stage:	PCTFE
Seat seals 2nd stage:	Stainless steel: FFKM, (EPDM)*, Brass: EPDM, (FKM)*
Body seals:	PCTFE (Stainless steel), PVDF (Brass)
Relief valve seat seals:	SS: FKM, (EPDM, FFKM)* Brass: EPDM, (FKM)*
Performance data:	see chapter 5
Basic design aspects:	see page 13
Pressure gauge range:	-1 - 1.5 bar (-15 - 40 psi) -1 - 5 bar (-15 - 75 psi) 0 - 315 bar (0 - 4500 psi)
Weight:	approx. 2.1 kg (type -14), 2.4kg (type -16/18)
Dimensions (wxhxd):	approx. 225x140x210 mm
Cylinder connections:	according to gas type, see chapter 5
Outlet:	NPT 1/4"f, optional tube fitting

* on request

ORDER CODE

Type	Material	Upstream pressure	Downstream pressure	Inlet	Outlet	Contact gauge	Gas type
FMD 522-14	BC	F	2	DIN	CL6	Ki	GAS
FMD 522-14	BC = brass	F = 230 bar/3300 psi	FMD 522	DIN	0=NPT 1/4"f	0 = without	Please
FMD 522-16	chrome-plated		2 a= 0.2 - 2 bar abs.	ANSI	CL6**	Ki = with	specify
FMD 522-18	SS = stainless		/3 - 30 psi abs.	AFNOR	CL8		
FMD 562-14	steel		3a = 0.2 - 3 bar abs.	NBN	CL 1/8"		
FMD 562-16			/3 - 45 psi abs.	BS 341	CL 1/4"		
FMD 562-18			FMD 562	CGA	NO6		
			1 = 0.2 - 1 bar / 3 - 15 psi	NEN			
			2 = 0.2 - 2 bar /3- 30 psi	UNI			

CYLINDER PRESSURE REGULATORS FMD 522/562-26/-27



Type -26



Type -27

Dual-stage, with inert gas purging, for inert, reactive, flammable and oxidizing gases and gas mixtures (not oxygen), purity max. 6.0, cylinder pressure 230 bar / 3300 psi, FMD 522: downstream pressure range 0.2 - 3 bar abs / 3 - 45 psi abs, FMD 562: downstream pressure range 0.2 - 2 bar / 3 - 30 psi

SPECIAL FEATURES

- Inert gas purging
- Optimum purge conditions with purge valve block
- Subatmospheric-pressure regulation (FMD 522)
- Downstream pressure virtually independent of upstream pressure due to dual-stage design
- Diaphragm shut-off valve
- Diaphragm regulator
- ATEX compliant adjustment knobs

DESCRIPTION

These pressure regulators consists of a cylinder connection, purge valve block with a check valve, purge inlet and outlet valve, pressure regulator body, upstream and downstream pressure gauges, diaphragm shut-off valve MVA 500 (only type-27), relief valve and outlet tube fittings. The use of contact gauge (accessories) in conjunction with alarm box (accessories) facilitates the monitoring of gas reserves.

APPLICATION

The upstream purge valve block allows for an external gas purging with inert gas. The purge volume is kept to a minimum (only cylinder connection) and the purge gases can be separately conveyed.

For this reason these regulators are especially suited to use with reactive, flammable, oxidizing and corrosive gases. It guarantees optimum purge conditions and with toxic gases maximum safety for the application and for the operator. The dual-stage design ensures the uniformity of the downstream pressure irrespectively of the level of the cylinder pressure.

FLOW SCHEMATIC

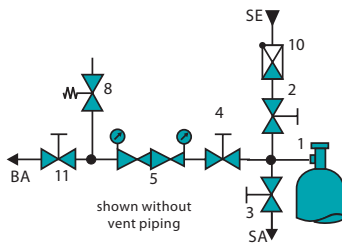

- 1 Cylinder connection
 - 2 Purge inlet valve
 - 3 Purge outlet valve
 - 4 Upstream shut-off valve
 - 5 Pressure regulator
 - 6 Upstream pressure gauge
 - 7 Downstream pressure gauge
 - 8 Relief valve
 - 10 Check valve
 - 11 Downstream shut-off valve (only type -27)
- BA Process gas outlet
SE Purge inlet
SA Purge outlet

TECHNICAL DATA

Body:	stainless steel 316L (1.4404) specially cleaned and electro-polished
Seat seals 1st stage:	PCTFE
Seat seals 2nd stage:	FFKM, (EPDM *)
Body seals:	PCTFE
Relief valve seat seals:	FKM, (EPDM, FFKM *)
Performance data:	see chapter 5
Basic design aspects:	see page 13
Pressure gauge range:	-1 - 1.5 bar (-15 - 40 psi)
	-1 - 5 bar (-15 - 75 psi)
	0 - 315 bar (0 - 4500 psi)
Option:	0 - 600 mbar (8.7 psi) with Ø 63 mm
Weight:	approx. 3.5 (type -26) / 3.9 kg (type -27)
Dimensions (w×h×d):	approx. 310×180×230 mm
Purge inlet:	check valve, tube fitting 6 mm
Purge outlet:	NPT 1/4" f, optional tube connection
Outlet:	NPT 1/4" f, optional tube fitting
Cylinder connections::	according to gas type, see chapter 5

*on request

ORDER CODE

Type	Material	Upstream pressure	Downstream pressure	Inlet	Outlet	Contact gauge	Vent piping	Gas type
FMD 522-27	SS	F	2	DIN	CL6	Ki	A	GAS
FMD 522-26	SS = stainless steel	F = 230 bar / 3300 psi	FMD 522 2a = 0.2 - 2 bar abs. / 1 - 30 psi abs.	DIN ANSI AFNOR	0=NPT 1/4" f CL3** CL6 (standard)	0 = without Ki = with	0 = without A = with (Only in conjunction with RV)	Please specify (no O2)
FMD 562-26			3a = 0.2 - 3 bar abs. / 1 - 45 psi abs.	NBN BS 341	CL6 CL8			
FMD 562-27			FMD 562 1 = 0.2 - 1 bar / 1 - 15 psi 2 = 0.2 - 2 bar / 1 - 30 psi	CGA NEN UNI	CL 1/8"			

CYLINDER PRESSURE REGULATORS FMD 530-14/-16/-18

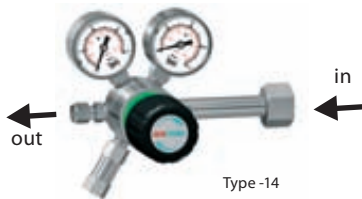

Type -14

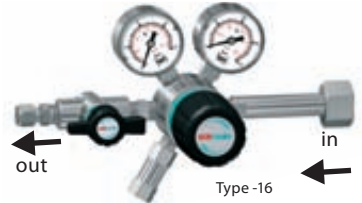

Type -16



Type -18

**Single-stage,
for inert, reactive, flammable and oxidizing gases and
gas mixtures,
purity max. 6.0,
cylinder pressure 315 bar/ 4500 psi,
downstream pressure range 0.5 - 200 bar / 7 - 2900 psi**

SPECIAL FEATURES

- For 300 bar cylinders
- Diaphragm regulator
- ATEX compliant adjustment knobs

DESCRIPTION

The FMD 530-14 consists of a cylinder connection, pressure regulator body, upstream and downstream pressure gauges, relief valve (by downstream pressure >50bar RV on request) and outlet tube fittings. The use of contact gauge (accessories) in conjunction with alarm box (accessories) facilitates the monitoring of gas reserves.

APPLICATION

The cylinder pressure regulator series MD 530 has a broad range of uses and excellent performance.

Type-14 is the basic model for independent gas supply with 300 bar cylinder.

The type-16 allows shut-off/opening of the gas flow while maintaining the pressure regulator's adjustment and type-18 allows for pressure regulating as well as a finer control of gas flow.

TECHNICAL DATA

Body:	stainless steel 316L (1.4404) specially cleaned and electro-polished or Brass
	2.0401.26 specially cleaned, nickel-plated and chrome-plated
Seat seals:	PCTFE
Body seals:	PCTFE (Stainless steel), PVDF (Brass)
Relief valve:	Outlet NPT1/4"f, for downstream pressure >50bar AV*
Relief valve seat seals:	SS: FKM, (EPDM, FFKM)*, Brass: EPDM, (FKM)*,
Performance data:	see chapter 5
Basic design aspects:	see page 13
Pressure gauge range:	-1 - 10 bar (-15 - 145 psi)
	0 - 25 bar (0 - 365 psi)
	0 - 40 bar (0 - 600 psi)
	0 - 80 bar (0 - 1150 psi)
	0 - 315 bar (0 - 4500 psi)
	0 - 400 bar (0 - 5800 psi)
Weight:	approx. 1.5 kg (type -14), 1.8 kg (type -16/18)
Dimensions (wxhxd):	approx. 225x140x 125 mm
Outlet:	NPT 1/4"f. optional tube fitting
Cylinder connections:	according to gas type, see chapter 5
	*on request

FLOW SCHEMATIC

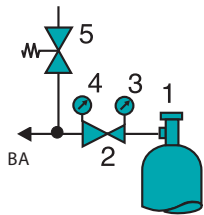

Type -14

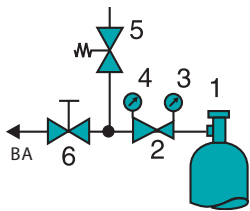

Type -16 /18

- 1 Cylinder connection
 - 2 Pressure regulator
 - 3 Upstream pressure gauge
 - 4 Downstream pressure gauge
 - 5 Relief valve
 - 6 Downstream shut-off valve (type -16)
/ regulating valve (type -18)
- BA Process gas outlet

ORDER CODE

Type	Material	Upstream pressure	Downstream pressure	Inlet	Outlet	Contact gauge	Gas type
FMD 530-14	BC	G	14	DIN	CL6 BC	Ki	GAS
FMD 530-14	BC = brass	G = 315 bar	6 = 0.5 - 6 bar / 7 - 85 psi	DIN	0=NPT 1/4"f	0 = without	Please
FMD 530-16	chrome-plated	/4500 psi	14 = 1 - 14 bar/15 - 150 psi	ANSI	CL3**	Ki = with	specify
FMD 530-18	SS = stainless steel		28 = 2.5 - 28 bar / 35 - 400 psi	AFNOR	CL6 (standard)		
			50 = 2.5 - 50 bar/35 - 720 psi	NBN	CL 1/8"		
			200 = 10 - 200 bar	BS 341	CL 1/4"		
			/150 - 2900 psi (not Type -18)	CGA	NO6		
				NEN			
				UNI			

CYLINDER PRESSURE REGULATORS FMD 532-14/-16/-18

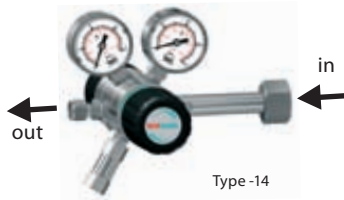

Type -14

**Dual-stage,
for inert, reactive, flammable and oxidizing gases and gas mixtures,
not for oxygen,
purity max. 6.0,
cylinder pressure 315 bar/ 4500 psi,
downstream pressure range 0.2 - 10.5 bar/ 3 -150 psi**

SPECIAL FEATURES

- For 300 bar cylinders
- Downstream pressure is independent of the upstream pressure due to the dual-stage design
- Higher reliability through the use of a relief valve

DESCRIPTION

The FMD 532 consists of a cylinder connection, pressure regulator body, upstream and downstream pressure gauges, relief valve and downstream regulating valve (FMD 532-18) or shut off valve (FMD 532-16). The use of contact gauge (accessories) in conjunction with alarm box (accessories) facilitates the monitoring of gas reserves.

APPLICATION

The cylinder pressure regulator series MD 532 has a broad range of uses and excellent performance. The FMD 532-14 is the basic model for location-independent gas supply with 300 bar cylinder. The FMD 532-16 allows shut-off/opening of the gas flow while maintaining the pressure regulator's adjustment. The FMD 532-18 allows for pressure regulating as well as a finer apportioning of gas flow.

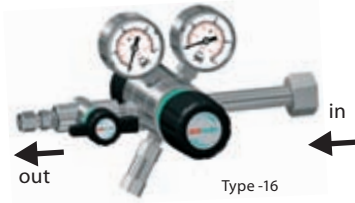

Type -16

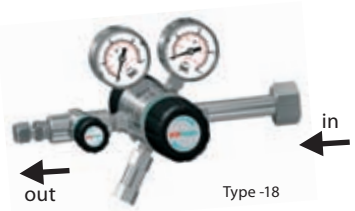

Type -18

TECHNICAL DATA

Body:	stainless steel 316L (1.4404) specially cleaned and electro-polished or brass 2.0401.26 specially cleaned, nickel-plated and chrome-plated
Dimensions (w×h×d):	approx. 175×139×206 mm
Seat seals:	PCTFE
Body seals:	PCTFE (Stainless steel), PVDF (Brass)
Relief valve seat seals:	SS: FKM, (EPDM, FFKM)*, Brass: EPDM, (FKM)*,
Performance data:	see chapter 5
Basic design aspects:	see page 13
Pressure gauge range:	0 - 400 bar (0 - 5800 psi) -1 - 5 bar (-15 - 73 psi) -1 - 10 bar (-15 - 145 psi) -1 - 18 bar (-15 - 260 psi)
Weight:	approx. 2.1kg (type-14), 2.4kg (type-16/18)
Dimensions (w×h×d):	approx. 139×206 mm, 175 mm (-14), 223 mm (-16 and -18)
Cylinder connections:	according to gas type, see chapter 5
Outlet:	NPT 1/4" f, optional tube fitting

*on request

FLOW SCHEMATIC

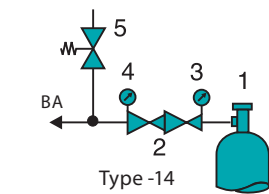

Type -14

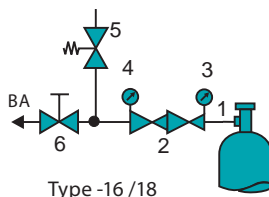

Type -16 /18

- 1 Cylinder connection
 - 2 Pressure regulator
 - 3 Upstream pressure gauge
 - 4 Downstream pressure gauge
 - 5 Relief valve
 - 6 Downstream shut-off valve (type -16)
/ regulating valve (type -18)
- BA Process gas outlet

ORDER CODE

Type	Material	Upstream pressure	Downstream pressure	Inlet	Outlet	Contact gauge	Gas type
FMD 532-14	BC	G	10	DIN	CL6	Ki	Gas
FMD 532-14	BC = brass	G = 315 bar	3 = 0.2 - 3 bar / 3 - 45 psi	DIN	0=NPT 1/4" f	0 = without	Please
FMD 532-16	chrome-plated	/4500 psi	6 = 0.5 - 6 bar/7 - 85 psi	ANSI	CL6 (standard)	Ki = with	specify
FMD 532-18	SS = stainless steel		10.5 = 1 - 10.5 bar/15 - 150 psi	AFNOR NBN BS 341 CGA NEN, UNI	CL 1/8" CL 1/4" NO6		

LINE PRESSURE REGULATORS LMD 500/530-01/-03/-04/-05

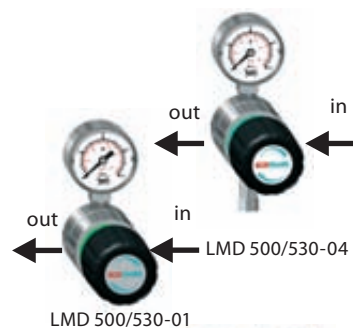

**Single-stage,
for inert, reactive, flammable and oxidizing gases and gas mixtures,
purity max. 6.0,
inlet pressure LMD 500: 40 bar / 600 psi,
optional 230 bar / 3300 psi, LMD 530: 315 bar / 4500 psi,
downstream pressure range LMD 500: 0.2 - 50 bar / 3- 725 psi,
LMD 530: 0.5- 10.5 bar / 7 - 150 psi**

SPECIAL FEATURES

- Excelent pressure adjustment
- Compact design
- 4 or 6 port configuration

DESCRIPTION

A broad application spectrum through the 4-port configuration (type -01/-04) or 6-Port-configuration (type -03/-05), which can be delivered respectively, with (type -04/-05) or without (type -01/-03) a relief valve. With type-03 and type-05 the use of contact gauge (accessories) in conjunction with alarm box (accessories) facilitates the monitoring of gas reserves.

APPLICATION

The LMD 500/530 reduces line pressure to give a lower supply pressure. Through its compact design this regulator is especially well suited for use in analytical or chemical apparatuses or processes.

TECHNICAL DATA

Body:	stainless steel 316L (1.4404) specially cleaned and electro-polished or brass CW614 (CuZn39Pb3) specially cleaned, nickel-plated and chrome-plated
Seat seals:	PCTFE
Body seals:	PCTFE, PVDF (Brass)
Relief valve seat seals:	SS: FKM, (EPDM, FFKM)*, Brass: EPDM, (FKM)*
Performance data:	see chapter 5
Basic design aspects:	see page 13
Pressure gauge range:	-1 - 5 bar (-15 - 73 psi) / -1 - 10 bar (-15 - 145 psi), 0 - 25 bar (0 - 365 psi) / 0 - 40 bar (0 - 600 psi), 0 - 80 bar (0 - 1150 psi) / 0 - 315 bar (0 - 4500 psi) 0 - 400 bar (0 - 5800 psi)
Weight:	approx. 1.1kg (type -01), 1.2kg (type -03)
Dimensions (wxhxd):	approx. 115x140x120 to 140 mm
Inlet/Outlet:	NPT 1/4" f, optional tube fitting

*on request

CONNECTIONS (FRONT VIEW)

TYPE -01/-04

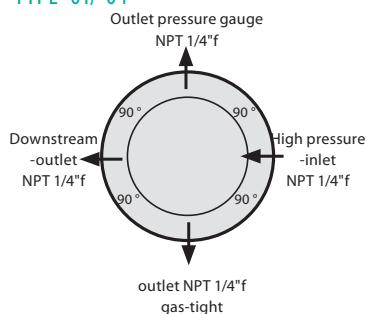

TYPE -03/-05

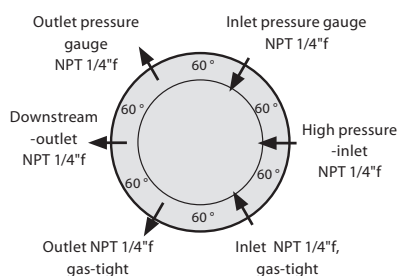

DIMENSIONS

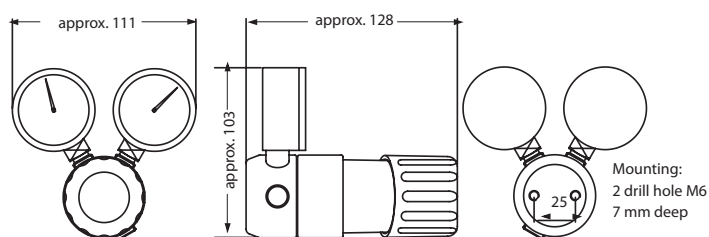

ORDER CODE

Type	Material	Upstream pressure	Downstream pressure	Inlet	Outlet	Contact gauge	Gas type
LMD 500-01	BC	E	3	CL6 BC	CL6 BC	Ki	GAS
LMD 500-01	BC = brass	E = 50 bar	3 = 0.2-3 bar/3-45 psi	0=NPT 1/4" f	same as inlet	0 = without	Please specify
LMD 500-03	chrome-plated	/ 720 psi	6 = 0.5 - 6 bar/7-85 psi	CL6**		Ki = with	
LMD 500-04	SS = stainless	F = 230 bar	14 = 1 - 14 bar/15-200 psi	CL8		(only for	
LMD 500-05	steel	/3300 psi	50 = 2.5-50 bar/35-720 psi	CL10		Type -03	
LMD 530-01		LMD 530:	LMD 530:	CL12		and -05	
LMD 530-03		G=315 bar/	6 = 0.5-6 bar/7-85 psi	BC = brass			
LMD 530-04		4500 psi	10.5 = 1-10.5 bar/15-150 psi	chrome-plated			
LMD 530-05				SS = stainless steel			

LINE PRESSURE REGULATORS LMD 502-03/-05

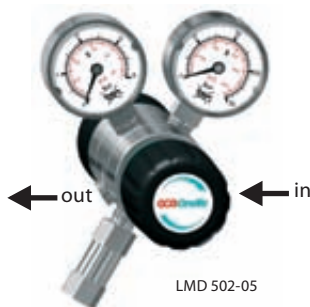

**Dual-stage,
for inert, reactive, flammable and oxidizing gases and
gas mixtures,
purity max. 6.0
inlet pressure 230 bar / 3300 psi,
downstream pressure range 0.2 - 10.5 bar / 3 - 150 psi**

SPECIAL FEATURES

- Downstream pressure is independent of upstream pressure
- Precise pressure allocation
- Space saving multi-connection possibilities

DESCRIPTION

This pressure regulator reduces the upstream pressure to a lower downstream pressure. The dual-stage design ensures the uniformity of the downstream pressure irrespectively of the upstream pressure. The use of contact gauge (accessories) in conjunction with alarm box (accessories) facilitates the monitoring of gas reserves. A broad application spectrum through the the multiple inlet/outlet connections.

APPLICATION

The LMD 502-03 stands out for its precise pressure allocation, minimum space requirement and uniformity of downstream pressure. For this reason this series is particularly suited to high-performance and stabil gas supply as would be needed for analytical applications or where space saving pressure regulating with short connection ways to point-of-use outlets are required.

TECHNICAL DATA

Body:	stainless steel 316L (1.4404) specially cleaned and electro-polished or brass CW614 (CuZn39Pb3) specially cleaned, nickel-plated and chrome-plated
Seat seals 1st stage:	PCTFE
Seat seals 2nd stage:	PTFE
Body seals:	PCTFE (Stainless steel), PTFE (Brass)
Relief valve seat seals:	Stainless steel: FKM, (EPDM, FFKM)* Brass: EPDM, (FKM)*
Performance data:	see chapter 5
Basic design aspects:	see page 13
Pressure gauge range:	-1 - 5 bar (-15 - 75 psi) -1 - 10 bar (-15 - 145 psi) -1 - 18 bar (-15 - 260 psi) 0 - 315 bar (0 - 4500 psi)
Weight:	approx. 1.8kg (type-03), 1.9kg (type-05)
Dimensions (w×h×d):	approx. 115×140×199 to 211 mm
Inlet-/Outlet:	NPT 1/4" f, optional tube fitting

* on request

CONNECTIONS (FRONT VIEW)

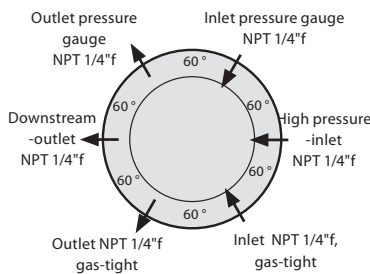

ORDER CODE

Type	Material	Upstream pressure	Downstream pressure	Inlet	Outlet	Contact gauge	Gas type
LMD 502-03	BC	F	3	CL6 BC	CL6 BC	Ki	GAS
LMD 502-03	BC = brass	F = 230 bar	1 = 0.2 - 1 bar	0=NPT 1/4" f	0=NPT 1/4" f	0 = without	Please
LMD 502-05	chrome-plated SS = stainless steel	/3300 psi	/ 3 - 15 psi 3 = 0.2 - 3 bar / 3 - 45 psi 6 = 0.5 - 6 bar / 7 - 85 psi 10 = 1 - 10.5 bar / 15 - 150 psi	CL6** CL8 CL10 CL12 BC = brass chrome-plated SS = stainless steel	CL6** CL8 CL10 CL12 BC = brass chrome- plated SS = stainless steel	Ki = with	specify

LINE PRESSURE REGULATORS LMD 510-01/-03/-04/-05



**Single-stage,
for inert, reactive, flammable and oxidizing gases and
gas mixtures,
purity max. 6.0,
inlet pressure 12 bar/ 175 psi,
downstream pressure range 0.2 - 3 bar abs. / 3 - 45 psi abs.**

SPECIAL FEATURES

- Subatmospheric-pressure regulation
- Compact design
- 4 or 6 port configuration

DESCRIPTION

A broad application spectrum through the 4-port configuration (type -01/-04) or 6-Port-configuration (type -03/-05), which can be delivered respectively, with (type -04/-05) or without (type -01/-03) a relief valve. The use of contact gauge (accessories) in conjunction with alarm box (accessories) facilitates the monitoring of gas reserves.

Application

The pressure regulator series MD 510 reduces low upstream pressure to a very low downstream pressure down to 0.2 bar absolut and is suitable for subatmospheric-pressure regulation.

TECHNICAL DATA

Body:	stainless steel 316L (1.4404) specially cleaned and electro-polished or brass CW614 (CuZn39Pb3) specially cleaned, nickel-plated and chrome-plated
Seat seals:	Stainless steel: FFKM, (EPDM)*
Brass:	EPDM, (FKM)*
Body seals:	PCTFE (Stainless steel), PVDF (Brass)
Relief valve seat seals:	Stainless steel: FKM, (EPDM, FFKM)*
Brass:	EPDM, (FKM)*
Performance data:	see chapter 5
Basic design aspects:	see page 13
Pressure gauge range:	-1 - 1.5 bar (-15 - 40 psi) -1 - 5 bar (-15 - 75 psi) -1 - 18 bar (-15 - 260 psi)
Optional:	0 - 600 mbar (0 - 8.5 psi) with diameter 63 mm
Weight:	approx. 1.1 kg (type -01), 1.2kg (type -03)
Dimensions (wxhxd):	approx. 115x140 x120 to 140 mm
Inlet/Outlet:	NPT 1/4" f, optional tube fitting
Dimensions + drawing:	see page 22
	*on request

CONNECTIONS (FRONT VIEW)

TYPE -01/-04

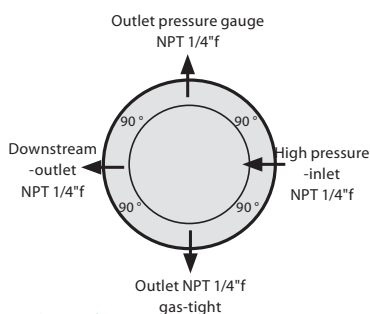

TYPE -03/-05

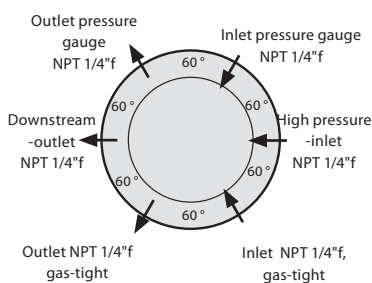

ORDER CODE

Type	Material	Upstream pressure	Downstream pressure	Inlet	Outlet	Contact gauge	Gas type
LMD 510-03	BC	D	2	CL6 BC	CL6 BC	Ki	GAS
LMD 510-03	BC = brass	D = 12 bar	2 = 0.2 - 2 bar abs./	0=NPT 1/4" f	0=NPT 1/4" f	0 = without	Please
LMD 510-01	chrome-plated	/175 psi	3 - 30 psi abs.	CL6**	CL6**	Ki = with	specify
LMD 510-04	SS = stainless		3 = 0.2 - 3 bar abs./	CL8	CL8	(only for	
LMD 510-05	steel		3 - 45 psi abs.	CL10 CL12	CL10 CL12	Type -03 and -05)	
				BC = brass chrome-plated SS = stainless steel	BC = brass chrome- plated SS = stainless steel		

LINE PRESSURE REGULATORS LMD 522-03/-05

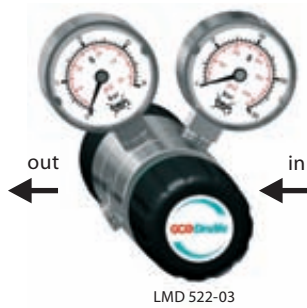

LMD 522-03



LMD 522-05

**Dual-stage,
for inert, reactive, flammable and oxidizing gases
and gas mixtures,
purity max. 6.0,
upstream pressure 230 bar / 3300 psi,
downstream pressure range 0.2 - 3 bar abs. / 3 - 45 psi abs.**

SPECIAL FEATURES

- Subatmospheric-pressure regulation
- Downstream pressure is independent of upstream pressure

DESCRIPTION

These pressure regulators offer a broad application spectrum through the 4-port or 6-port configurations available. Type LMD 522-05 is delivered with a relief valve. The use of contact gauge (accessories) in conjunction with alarm box (accessories) facilitates the monitoring of gas reserves.

APPLICATION

The pressure regulator series MD 522 reduces cylinder pressure to diverse very low downstream pressures down to 0.2 bar. The dual-stage design ensures that the upstream pressure remains independent of the downstream pressure. Subatmospheric-pressure regulation possible.

TECHNICAL DATA

Body:	stainless steel 316L (1.4404) specially cleaned and electro-polished or brass
	CW614 (CuZn39Pb3) specially cleaned, nickel-plated and chrome-plated
Seat seals 1st stage:	PCTFE
Seat seals 2nd stage:	Stainless steel: FFKM, (EPDM)*, Brass: EPDM, (FKM)*
Body seals:	PCTFE (SS), PVDF (Brass)
Relief valve seat seals:	Stainless steel: FKM, (EPDM, FFKM)*
	Brass: EPDM, (FKM)*
Performance data:	see chapter 5
Basic design aspects:	see page 13
Pressure gauge range:	-1 - 1.5 bar (-15 - 40 psi)
	-1 - 5 bar (-15 - 75 psi)
	0 - 315 bar (0 - 4500 psi)
Option:	0 - 600 mbar (8.7 psi) with Ø 63 mm
Weight:	approx. 1.8 kg (Type -03), 1.9 kg (Type -05)
Dimensions (w×h×d):	approx. 115×140×120 - 140 mm
Inlet-/Outlet:	NPT 1/4" f, optional tube fitting

*on request

CONNECTIONS (FRONT VIEW)

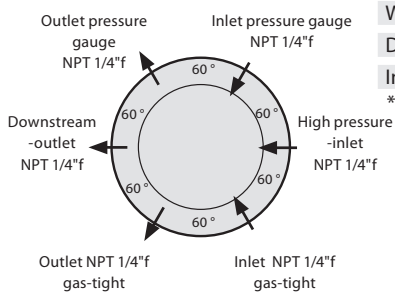

ORDER CODE

Type	Material	Upstream pressure	Downstream pressure	Inlet	Outlet	Contact gauge	Gas type
LMD 522-03	BC	F	2	CL6 BC	CL6 BC	Ki	GAS
LMD 522-03	BC = brass	F = 230 bar	2 = 0.2 - 2 bar abs./	0=NPT 1/4" f	0=NPT 1/4" f	0 = without	Please
LMD 522-05	chrome-plated	/3300 psi	3 - 30 psi abs.	CL6**	CL6**	Ki = with	specify
	SS = stainless		3 = 0.2 - 3 bar abs./	CL8, CL10	CL8, CL10		
	steel		3 - 45 psi abs.	CL12	CL12		
				BC = brass	BC = brass		
				chrome-plated	chrome-plated		
				SS = stainless steel	SS = stainless		

LINE PRESSURE REGULATORS LMD 500-PA

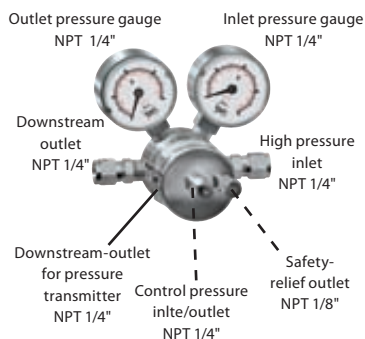

Single-stage, for inert, reactive, flammable and oxidizing gases and gas mixtures, purity max. 6.0, upstream pressure: 20/40/200 bar downstream pressure range 0.5 to 6 bar control pressure 1.5 - 8 bar

SPECIAL FEATURES

- Pneumatic control
- Electronic control with magnetic valve (optional)
- High precision adjustability

DESCRIPTION

The pressure regulator is equipped with upstream and downstream pressure gauges (also available without). A second downstream pressure outlet serves as inlet for a pressure transmitter. The regulation of the downstream pressure is achieved by way of a pneumatic control with the help of a control block and a process regulator (available optionally). The downstream pressure can in this way be very precisely adjusted (see regulating characteristics). The control and viewing element of this regulator is outfitted with 3 buttons and an LCD Matrix-display. A manual mode, a configuration mode and an automatic mode are provided.

APPLICATION

The LMD 500-PA reduces line pressure to a lower supply pressure and is a good solution when the downstream pressure cannot or should not be set directly at the pressure regulator. The integration of an automatic electronic control can be done best in this manner.

CONFIGURATION DIAGRAM

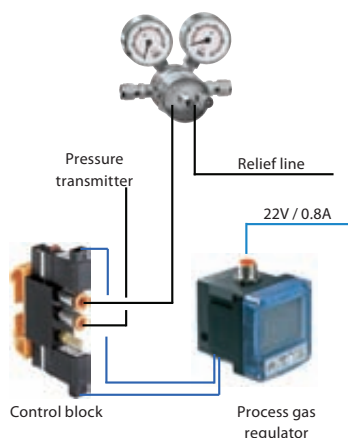

TECHNICAL DATA

PRESSURE REGULATOR

Body:	stainless steel 316L (1.4404) specially cleaned and electro-polished or brass
	CW614 (CuZn39Pb3) specially cleaned, nickel-plated and chrome-plated
Configuration:	4- or 6-Port
Seat seal:	PCTFE
Body seals:	PCTFE, PVDF (Brass)
Downstream pressure:	0.5 - 6 bar
Control pressure:	1.5 - 8 bar
Pressure gauge range:	-1 - 10 bar, 0 - 50 bar, 0 - 80 bar, 0 - 315 bar
Weight:	approx. 1.1 kg
Dimensions (w×h×d):	approx. 50×140×120 to 140 mm
Process gas-in-/outlet:	NPT 1/4" f, optional tube fitting

PROCESS REGULATOR

Power consumption:	24V DC / 1A
Sampling frequency:	300 Hz
Installation position:	any direction
Ambient temperature:	-25 °C to 70 °C (not for electronic)
Protection category:	IP65 in accord. with EN 60529

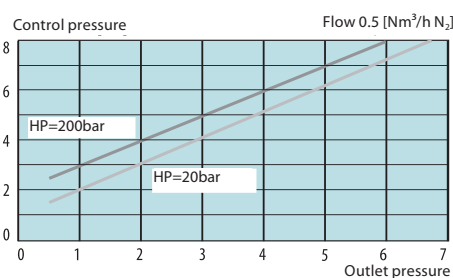
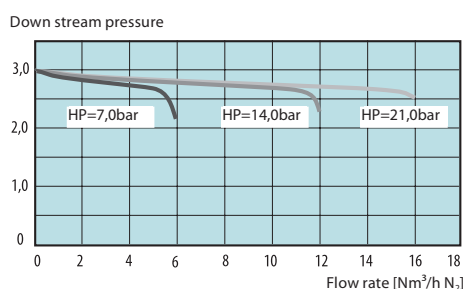

ORDER CODE

Type	Material	Upstream pressure	Downstream pressure	Inlet	Outlet	Gas type
LMD 500-PA	BC	E	6	CL6 SS	CL6 SS	GAS
LMD 500-PA	SS = stainless steel BC = brass chrome-plated	D = 20 bar E = 40 bar F = 200 bar	6 = 0.5 - 6 bar	0 = NPT 1/4" f CL6* BC = brass chrome-plated SS = stainless steel	0 = NPT 1/4" f CL6* BC = brass chrome-plated SS = stainless steel	Please specify

LINE PRESSURE REGULATORS LMD 545-01/-03

**Single-stage,
for inert, reactive, flammable and oxidizing gases and gas mixtures,
purity max. 6.0,
upstream pressure: 12 / 40 bar
downstream pressure range 0.02 - 3 bar**

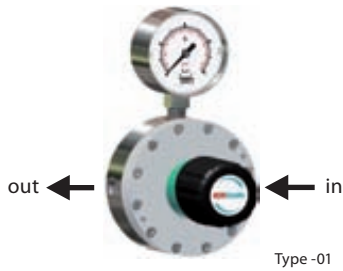

SPECIAL FEATURES

- Low downstream pressure
- Very fine adjustments possible
- Higher Flow rates

DESCRIPTION

The large housing diameter of these pressure regulators allows for a large metal diaphragm and with it a very fine adjustment of the downstream pressure by comparatively high flow rates of up to 0.02 bar. The Pressure regulator can be supplied in either 4-Port (LMD 545-01) or 6-Port (LMD 545-03) versions.

APPLICATION

The LMD 545 reduces the line pressure by very small increments to a very low supply pressure.

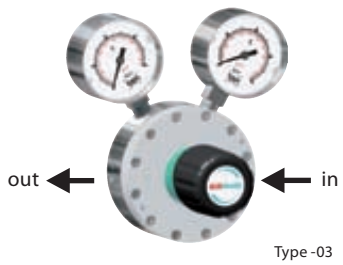

TECHNICAL DATA

Body:	stainless steel 316L (1.4404) specially cleaned and electro-polished or Brass CW614 (CuZn39Pb3) specially cleaned, nickel-plated and chrome-plated
Upstream pressure:	12 / 40 bar
Configuration:	4-Port-Version (Type -01) or 6 Port-Version (Type -03)
Downstream pressure:	20 - 250 mbar / 100 - 1300 mbar (12 bar Version) 150 - 500 mbar / 150 - 3000 mbar (40 bar Version)
Performance data:	see chapter 5
Basic design aspects:	see page 13
Seat seals:	EPDM, FKM (Brass)
Body seals:	PCTFE, PVDF (Brass)
Pressure gauge range:	600 mbar / 1.5 bar / 5 bar
Weight:	approx. 2.4 (Type -01) / 2.5 kg (Type -03)
Dimensions (w×h×d):	approx. 150×230×150 mm
Inlet-/Outlet:	NPT 1/4" f, optional tube fitting

CONNECTIONS (FRONT VIEW)

TYPE -01

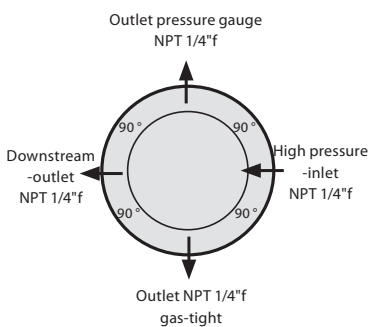

TYPE -03

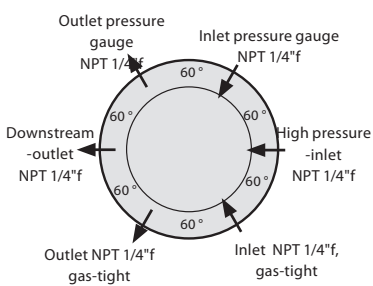

DIMENSIONS:

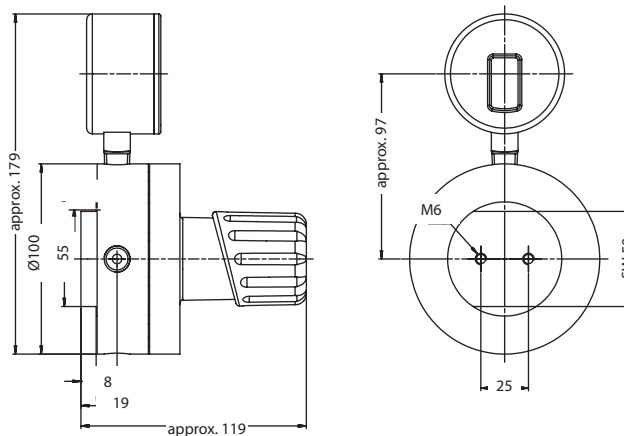

ORDER CODE

Type	Material	Upstream pressure	Downstream pressure	Inlet	Outlet	Gas type
LMD 545-01	BC	D	250	CL6 BC	CL6 BC	Gas
LMD 545-01	BC = brass	D = 12 bar	250 = 20 - 250 mbar	0=NPT 1/4" f	0=NPT 1/4" f	Please specify
LMD 545-03	chrome-plated	E= 40 bar	1300 = 100 - 1300 mbar	CL6*	CL6*	
	SS = stainless steel		40 bar Version: 500 = 0.15 - 0.5 bar 3000 = 0.15 - 3.0 bar	BC = brass chrome-plated SS = stainless steel	BC = brass chrome-plated SS = stainless steel	

GAS SUPPLY PANELS SMD 500/530-16/-24/-25

**Single-stage,
for inert, reactive, flammable and oxidizing gases and
gas mixtures,
purity max. 6.0
inlet pressure 230/315 bar / 3300/4500 psi
downstream pressure range 1 - 200 bar / 14 - 2900 psi**

SPECIAL FEATURES

- Gas supply panel for standard applications (Type -16)
- Process gas purging (Type -24)
- Process gas purging and process gas outlet shut-off valve (Type -25)

DESCRIPTION

These gas supply panels are mounted onto a stainless steel panel and consist of a pressure regulator, inlet and outlet pressure gauges, a relief valve (by downstream pressure > 50 bar RV on request) and shut-off valves (type -16 at the outlet, type -24 at the inlet, type -25 at inlet and outlet) for the process gas. A choice of stainless steel coils or flexible high pressure hoses is available for the connection to the gas cylinder. The use of contact gauge (accessories) in conjunction with alarm box (accessories) facilitates the monitoring of gas reserves. Vent piping connected to the relief valve can be ordered optionally.

APPLICATION

Gas panels are permanently installed in the cylinder stock room or cabinet near the point of use and reduce the cylinder pressure to a lower line pressure. Through the subsequent piping system the gas is taken to the point of use. The type -24 allows for process gas purging to be carried out while cylinders are being changed. The type-25 design allows shutting-off of gas flow during cylinder change from the panel itself. Standard application for these panels: centralized or decentralized gas supply for highly sensitive analysis devices.

TECHNICAL DATA

Body:	stainless steel 316L (1.4404) specially cleaned and electro-polished or brass CW614 (CuZn39Pb3) specially cleaned, nickel-plated and chrome-plated
Relief valve:	Outlet NPT 1/4" f, downstream pressure > 50 bar RV on request
Seat seals:	PCTFE
Body seals:	PCTFE (SS), PVDF (Brass)
Relief valve seat seals:	SS: FKM, (EPDM, FFKM)*, Brass: EPDM, (FKM)*
Performance data:	see chapter 5
Basic design aspects:	see page 13
Pressure gauge range:	-1 - 10 bar (-15 - 145 psi) 0 - 25 bar (0 - 365 psi), 0 - 40 bar (0 - 600 psi) 0 - 80 bar (0 - 1150 psi), 0 - 315 bar (0 - 4500 psi) 0 - 400 bar (0 - 5800 psi)
Weight:	approx. 2.5 kg (type -16) / 2.74 kg (type -24) / 3 kg (type -25)
Dimensions (wxhxd):	approx. 250x155x185 mm
Purge outlet:	NPT 1/4" f or tube fitting
Inlet:	NPT 1/4" f, M 14x1.5 (optional) *on request

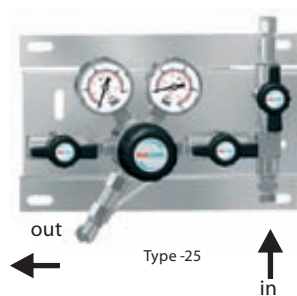
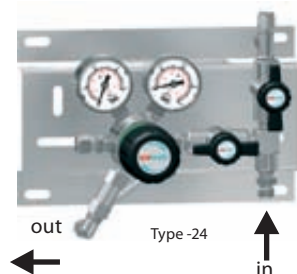
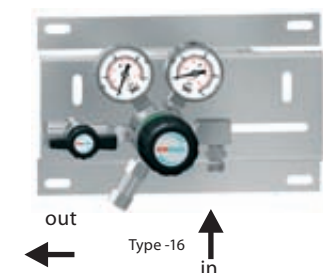

FLOW SCHEMATIC

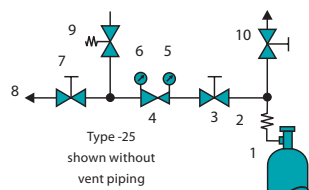

- 1 Cylinder connection
- 2 Coil
- 3 Purge outlet valve (not Type -16)
- 4 Pressure regulator - Single-stage
- 5 Upstream pressure gauge
- 6 Downstream pressure gauge
- 7 Process gas outlet shut-off valve (Type -25 only)
- 8 Process gas outlet
- 9 Relief valve
- 10 Purge outlet piping (not Type -16)

ORDER CODE

Type	Material	Upstream pressure	Downstream pressure	Inlet	Outlet	Contact gauge	Vent piping	Gas type
SMD 500-16	BC	F	14	N14	CL6 BC	Ki	A	Gas
SMD 500-16	BC = brass	F = 230 bar	14 = 1 - 14 bar	N14 =	0 = NPT 1/4" f	0 = without	0 = without	Please
SMD 500-24	chrome-plated	/3300 psi	/15 - 200 psi	NPT 1/4" f	CL6, CL8**	Ki = with	A = with	specify
SMD 500-25	SS = stainless		28 = 2.5 - 28 bar	M14x1.5	CL10, CL12		(Only in	
300 bar Versions:	steel		/35 - 400 psi	(optional)	BC = brass		conjunction	
SMD 530-16		G = 315 bar	50 = 2.5 - 50 bar		chrome-plated		with RV not	
SMD 530-24		/4500 psi	/35 - 720 psi				available for	
SMD 530-25			200 = 10 - 200 bar				Type-16)	
			/145 -2900 psi)					

GAS SUPPLY PANELS SMD 500/530-27



FLOW SCHEMATIC

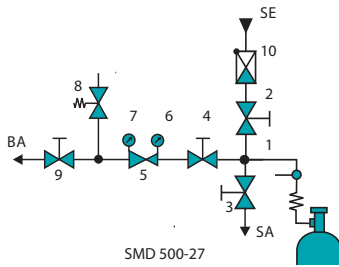

- 1 Inlet connection
- 2 Purge inlet valve
- 3 Purge outlet valve
- 4 Upstream shut-off valve
- 5 Pressure regulator
- 6 Upstream pressure gauge
- 7 Downstream pressure gauge
- 8 Relief valve
- 9 Downstream shut-off valve
- 10 Check valve
- SE Purge inlet
- SA Purge outlet
- BA Process gas outlet

Single-stage, with inert gas purging, for reactive, toxic, oxidizing and corrosive (optional Hastelloy inner parts) gas and gas mixtures, no oxygen purity max. 6.0, inlet pressure 230/315 bar / 3300/4500 psi, downstream pressure range 0.5 - 200 bar / 7 - 2900 psi

SPECIAL FEATURES

- With inert gas purging
- Optimum purge conditions with purge valve block
- Inlet and outlet shut-off valve
- Optional Hastelloy inner parts for corrosive gases

DESCRIPTION

The SMD 500-27 is mounted on a stainless steel panel and consists of a purge valve block with check valve, a purge inlet and purge outlet valves, pressure regulator, inlet and outlet pressure gauges, a relief valve and inlet and outlet shut-off valves for in- and outlet of the process gas. Stainless steel coils for connection to the gas cylinders are available. The use of contact gauge (accessories) in conjunction with alarm box (accessories) facilitates the monitoring of gas reserves. Vent gas piping for attachment to the relief valve can be ordered as an optional extra (by downstream pressure of >50bar RV on request).

APPLICATION

Gas panels are permanently installed in the cylinder stock room or cabinet near the point of use and reduce the cylinder pressure to a lower line pressure. Through the subsequent piping system the gas is taken to the point of use. The positioning of the purge block on the inlet side reduces the purge volume to a minimum (only with cylinder connection) and allows for a separate discharge for the purge gases. The SMD 500-27 guarantees optimum purge conditions even when using toxic gases and so offers maximum safety for the user and the application.

This design with external gas purging offers the following advantages:

1. Purging the residual gas in the system before a cylinder change improves personnel safety levels.
2. Maintaining gas purity by purging the atmospheric air which has penetrated the system during cylinder changing.
3. Purging with dry inert gas reduces humidity and extends the expected live span when corrosive gases are used.

TECHNICAL DATA

Body:	stainless steel 316L (1.4404) specially cleaned and electro-polished
Relief valve:	Outlet NPT 1/4"f, downstream pressure > 50 bar RV *
Seat seals:	PCTFE
Relief valve seat seals:	FKM, (EPDM, FFKM) *
Performance data:	see chapter 5
Basic design aspects:	see page 13
Pressure gauge range:	-1 - 10 bar (-15 - 145 psi), 0 - 25 bar (0 - 365 psi) 0 - 40 bar (0 - 600 psi), 0 - 80 bar (0 - 1150 psi) 0 - 315 bar (0 - 4500 psi)
Weight:	approx. 4.0 kg
Dimensions (w×h×d):	approx. 305×235×185 mm
Purge inlet:	check valve, Tube fitting 6 mm
Purge outlet:	NPT 1/4"f, optional tube fitting
Inlet:	NPT 1/4"f, M 14×1,5 (optional)
Outlet:	NPT 1/4"f, optional Tube fitting

*on request

ORDER CODE

Type	Material	Upstream pressure	Downstream pressure	Inlet	Outlet	Contact gauge	Vent piping	Gas type
SMD 500-27	SS	F	6	N14	CL6 SS	Ki	A	GAS
SMD 500-27	SS = stainless steel	F = 230 bar /3300 psi	6 = 0.5 - 6 bar / 7 - 85 psi 14 = 1 - 14 bar /15 - 200 psi	N14 = NPT 1/4"f M14×1.5 (optional)	0=NPT 1/4"f CL6** CL8 CL10 CL12 SS = stainless steel	0 = without Ki = with	0 = without A = with (Only in conjunction with RV)	Please specify (no O2)
SMD 530-27		G = 315 bar /4500 psi	50 = 2.5 - 50 bar /35 - 720 psi 200 = 10 - 200 bar /145 - 2900 psi					

GAS SUPPLY PANELS SMD 502/532-16/-24/-25

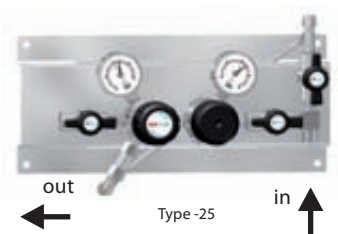
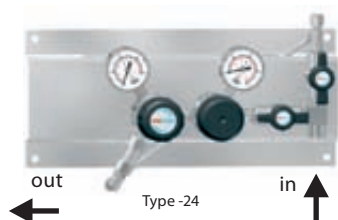
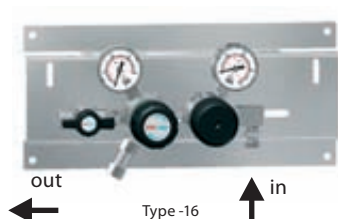

**Dual-stage,
for inert and flammable gases and gas mixtures,
purity max. 6.0,
inlet pressure 230/315 bar / 3300/4500 psi,
downstream pressure range 0.2 - 10.5 bar / 1 - 150 psi**

SPECIAL FEATURES

- Downstream pressure is independent of the upstream pressure due to the dual-stage design
- Gas supply panel for standard applications (Type -16)
- Process gas purging (Type -24)
- Process gas purging and process gas outlet shut-off valve (Type -25)

DESCRIPTION

These gas supply panels are mounted onto a stainless steel console and consist of a pressure regulator, inlet and outlet pressure gauges, a relief valve and shut-off valve (type -16 at the outlet, type -24 at the inlet, type -25 at inlet and outlet) for the process gas. A choice of stainless steel pigtailed or flexible high pressure hoses is available for the connection to the gas cylinder. The use of contact gauge (accessories) in conjunction with alarm box (accessories) facilitates the monitoring of gas reserves. Vent gas piping for attachment to the relief valve can be ordered as an optional extra.

APPLICATION

Dual station pressure regulators are permanently installed in the cylinder stock room or cabinet near the point of use and reduce the cylinder pressure to a lower, constant inlet pressure for the user. The type -24 allows for process gas purging to be carried out while cylinders are being changed. The type -25 design allows shutting-off of gas flow during cylinder change from the panel itself. Standard application for these panels: centralized or decentralized gas supply for highly sensitive analysis devices.

TECHNICAL DATA

Body:	stainless steel 316L (1.4404) specially cleaned and electro-polished or brass CW614 (CuZn39Pb3) specially cleaned, nickel-plated and chrome-plated
Relief valve:	Outlet NPT 1/4" f
Seat seals 1st stage:	PCTFE
Seat seals 2nd stage:	PTFE
Body seals:	PCTFE (SS), PTFE (Brass)
Relief valve seat seals:	Stainless steel: FKM, (EPDM, FFKM)* Brass: EPDM, (FKM)*
Performance data:	see chapter 5
Basic design aspects:	see page 13
Pressure gauge range:	-1 - 5 bar (-15 - 75 psi), -1 - 10 bar (-15 - 145 psi) -1 - 18 bar (-15 - 260 psi), 0 - 315 bar (0 - 4500 psi) 0 - 400 bar (0 - 5800 psi)
Dimensions (wxhxd):	approx. 400x155x160 mm
Weight:	approx. 3.5 (Type -16) / 4.1 kg (Type -24) / 4.4 kg (Type -25)
Inlet:	NPT 1/4" f, M 14x1.5 (optional)
Outlet:	NPT 1/4" f, optional tube fitting

*on request

FLOW SCHEMATIC

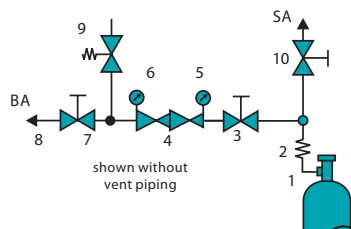

- 1 Cylinder connection
- 2 Coil
- 3 Upstream shut-off valve (Type -24+Type -25)
- 4 Pressure regulator - dual-stage
- 5 Upstream pressure gauge
- 6 Downstream pressure gauge
- 7 Process gas outlet shut-off valve (Type -16 + Type -25)
- 8 Process gas outlet
- 9 Relief valve
- 10 Purgre gas outlet valve (Type -24 + Type -25)
- SA Purge outlet
- BA Process gas outlet

ORDER CODE

Type	Material	Upstream pressure	Downstream pressure	Inlet	Outlet	Contact gauge	Vent piping	Gas type
SMD 502-16	BC	F	3	N14	CL6 BC	Ki	A	GAS
SMD 502-16	BC = brass	F = 230 bar	3 = 0.2-3 bar	N14 =	0=NPT 1/4" f	0 = without	0 = without	Please
SMD 502-24	chrome-plated	/3300 psi	/3 - 45 psi	NPT 1/4" f	CL6, CL8**	Ki = with	A = with	specify
SMD 502-25	plated	G = 315 bar	6 = 0.5-6 bar	M14x1.5	CL10, CL12		(Only in	
300 bar Versions:	SS = stainless	/4500 psi	/7 - 85 psi	(optional)	BC = brass		conjunction	
SMD 532-16	steel		10.5 = 0.5-10.5 bar		chrome-plated		with RV, not	
SMD 532-24			/7 - 145 psi		SS = stainless		available for	
SMD 532-25					steel		Type -16.)	

GAS SUPPLY PANELS SMD 502/532-27



FLOW SCHEMATIC

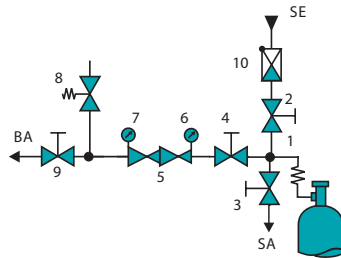

- 1 Inlet connection
- 2 Purge inlet valve
- 3 Purge outlet valve
- 4 Upstream shut-off valve
- 5 Cylinder pressure regulator
- 6 Upstream pressure gauge
- 7 Downstream pressure gauge
- 8 Relief valve
- 9 Downstream shut-off valve
- 10 Check valve
- SE Purge inlet
- SA Purge outlet
- BA Process gas outlet

Dual-stage, with inert gas purging, for reactive, toxic, highly corrosive, oxidizing and corrosive gases and corrosive gas and gas mixtures, no oxygen purity max. 6.0, inlet pressure 230/315 bar / 3300/4500 psi, downstream pressure range 0.2 - 10.5 bar / 1 - 150 psi

SPECIAL FEATURES

- With inert gas purging
- Optimum purge conditions with purge valve block
- Inlet and outlet shut-off valve
- Optional Hastelloy inner parts for corrosive gases

DESCRIPTION

These gas supply panels are mounted onto a stainless steel console and consist of a purge valve block with a check valve, purge inlet and outlet valves, pressure regulator, upstream and downstream gauges, a relief valve and shut-off valve for in- and outlet of the process gas.

Stainless steel coils are available for the connection to the gas cylinder. The use of contact gauge (accessories) in conjunction with alarm box (accessories) facilitates the monitoring of gas reserves. Vent gas piping for attachment to the relief valve can be ordered as an optional extra.

APPLICATION

Dual station pressure regulators are permanently installed in the cylinder stock room or cabinet near the point of use and reduce the cylinder pressure to a lower pressure for the user. Through the subsequent piping system the gas is taken to the point of use. The positioning of the purge block on the inlet side reduces the purge volume to a minimum and allows for a separate discharge for the purge gases. These pressure regulators guarantees optimum purge conditions even when using toxic gases and so offers maximum safety for the user and the application.

This design with inert gas purging offers the following advantages:

1. Purging the residual gas remaining in the system before a cylinder change improves personnel safety levels.
2. Maintaining gas purity by purging the atmospheric air which has penetrated the system during cylinder changing.
3. Purging with dry inert gas reduces humidity and extends the expected life span when corrosive gases are used.

TECHNICAL DATA

Body:	stainless steel 316L (1.4404) specially cleaned and electro-polished
Relief valve:	Outlet NPT 1/4"f
Seat seals 1st stage:	PCTFE
Seat seals 2nd stage:	PTFE
Body seals:	PCTFE
Performance data:	see chapter 5
Basic design aspects:	see page 13
Relief valve seat seals:	FKM, (EPDM, FFKM) *
Pressure gauge range:	-1 - 5 bar (-15 - 75 psi), -1 - 10 bar (-15 - 145 psi) 0 - 315 bar (0 - 4500 psi)
Dimensions (w×h×d):	approx. 400×235×185 mm
Weight:	approx. 5.1 kg
Purge inlet:	check valve, tube fitting 6 mm
Purge outlet:	NPT 1/4"f, optional tube fitting
Inlet:	NPT 1/4"f, M 14×1.5 (optional)
Outlet:	NPT 1/4"f, optional tube fitting

* on request

ORDER CODE

Type	Material	Upstream pressure	Downstream pressure	Inlet	Outlet	Contact gauge	Vent piping	Gas type
SMD 502-27	SS	F	3	N14	CL6	Ki	A	GAS
SMD 502-27	SS = stainless steel	F = 230 bar /3300 psi	3 = 0.2 - 3 bar / 3 - 45 psi 6 = 0.5 - 6 bar / 7 - 85 psi	N14 = NPT 1/4"f M14×1.5 (optional)	0=NPT 1/4"f CL6** CL8 CL10 CL12	0 = without Ki = with	0 = without A = with (Only in conjunction with AV)	Please specify (no O2)
SMD 532-27		G = 315 bar /4500 psi	10.5 = 0.5 - 10.5 bar / 7 - 145 psi					

GAS SUPPLY MANIFOLDS BMD 500/530-30/-32

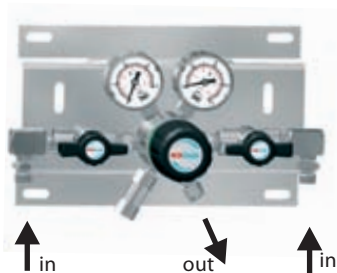

**Single-stage,
for inert, reactive, flammable and oxidizing gases and gas mixtures,
purity max. 6.0,
inlet pressure 230/315 bar / 3300/4500 psi,
downstream pressure range 1 - 200 bar / 14 - 2900 (3300) psi**

SPECIAL FEATURES

- Continuous gas supply even during cylinder change
- Fast manual switch-over to the reserve side
- Optional contact pressure gauges to monitor for gas supply failure
- Process gas purging (BMD 500-32)
- Connection for 2x1 cylinders, upgradable for 2x4 cylinders,

DESCRIPTION

These gas supply panels reduce the upstream pressure from 230 bar to downstream pressures of 1 to 200 bar. The BMD 500/530 is mounted onto a stainless steel console and consist of a pressure regulator and inlet and outlet gauges. The upstream shut-off valve enables the uninterrupted gas supply even while changing cylinders. The use of contact gauge (accessories) in conjunction with alarm box (accessories) facilitates the monitoring of gas reserves. The additional purge valve permits for purging the station with internal gas and thereby maintaining the gas purity even during a cylinder change. Vent piping for connection to the relief valve (by downstream pressure >50bar RV on request) can be ordered optionally for type -32.

APPLICATION

The manifold enables a continuous gas supply. The manifolds main advantage here is the ability to quickly change over to the reserve cylinder and the uninterrupted gas supply during the cylinder switch over. Standard application for these panels: centralized or decentralized gas supply for highly sensitive analytical devices.

TECHNICAL DATA

Body:	stainless steel 316L (1.4404) specially cleaned and electro-polished or brass
	CW614 (CuZn39Pb3) specially cleaned, nickel-plated and chrome-plated
Relief valve:	Outlet NPT 1/4"f (downstream pressure > 50 bar RV *)
Seat seals:	PCTFE
Body seals:	PCTFE (SS), PVDF (Brass)*
	Relief valve seat seals FKM, (EPDM, FFKM)*, EPDM, (FKM)*
Performance data:	see chapter 5
Basic design aspects:	see page 13
Pressure gauge range:	-1 - 18 bar (-15 - 260 psi), 0 - 80 bar (0 - 1150 psi) 0 - 315 bar (0 - 4500 psi), 0 - 400 bar (0 - 5800 psi)
Weight:	approx. 2.9 /3.8 kg
Dimensions (w×h×d):	approx. 400×200×185 mm (BMD 500-30); 440×200×185 mm (BMD 500-32)
Inlet:	NPT 1/4"f, M14×1.5 (optional)
Outlet:	NPT 1/4"f, optional tube fitting

*on request

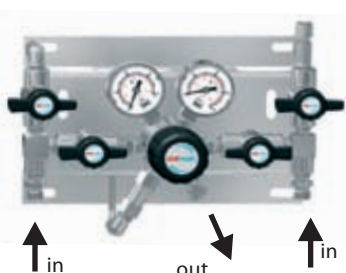
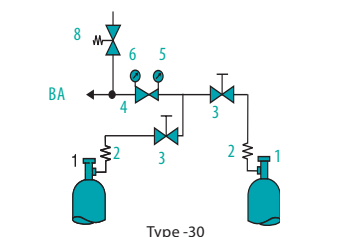

FLOW SCHEMATIC

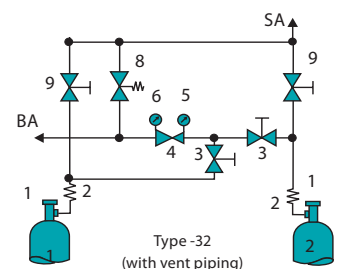

- 1 Inlet connection
- 2 Coil
- 3 Process gas inlet shut-off valve
- 4 Regulator single-stage
- 5 Upstream pressure gauge
- 6 Downstream pressure gauge
- 8 Relief valve
- 9 Purge outlet valve
- SA Purge outlet
- BA Process gas outlet

ORDER CODE

Type	Material	Upstream pressure	Downstream pressure	Inlet	Outlet	Contact gauge	Vent piping	Upgrade	Gas type
BMD 500-30	BC	F	14	N14	CL6 BC	Ki	A	M	GAS
BMD 500-30	BC = brass	F = 230 bar	14 = 1 - 14 bar	N14 =	0=NPT 1/4"f	0 =	0 = without	0 = without	Please
BMD 500-32	chrome-plated	/3300 psi	/15 - 200 psi	NPT 1/4"f	CL6, CL8**	without	A = with	M2 = 2x2	specify
300 bar Versions:			50 = 2.5 - 50 bar	M14x1.5	CL10, CL12	Ki = with	(On type-32	Cylinder	
BMD 530-30	SS = stainless steel	G = 315 bar	/35 - 720 psi	(optional)	BC = brass		only in	M3 = 2x3	
BMD 530-32	steel	/4500 psi	200 = 10 - 200 bar		chrome-plated		combination	Cylinder	
			/145 -2900 psi)				with RV)	M4 = 2x4	

GAS SUPPLY MANIFOLDS BMD 500/530-34/-35/-39

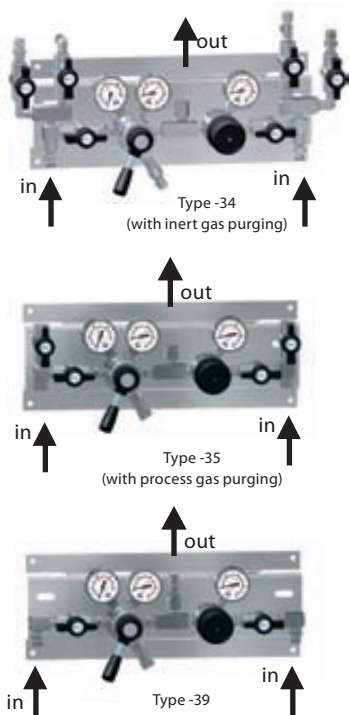

- 1 Pressure regulator
- 2 Upstream pressure gauge
- 3 Downstream pressure gauge
- 4 Process gas valve
- 5 Purge gas outlet valve
- 5a Purge gas inlet valve
- 6 Relief valve
- 7 Connection spirals
- 8 Gas cylinder
- 9 Check valve
- H Lever
- BA Process gas outlet
- SA Purge gas outlet
- SE Purge gas inlet

**Single-stage,
for inert, reactive, flammable and oxidizing gases and gas mixtures,
purity max. 6.0,
inlet pressure 230/315 bar / 3300/4500 psi,
preset downstream pressure 14 / 50 bar - 200 / 720 psi**

SPECIAL FEATURES

- Uninterrupted gas supply with semiautomatic switch over
- Indicator for active cylinder
- Low gas alarm signal with contact gauges (optional)
- Upgradable to max. 2x4 cylinders

DESCRIPTION

Pressure decreases in the active cylinder (or bundle) below a preset level which causes a semi-automatic switch to switch over to the full cylinder. This is achieved by two integrated pressure regulators (preset to slightly different delivery pressure levels), connected at their outlet ports. Moving the lever towards the full bank allows for the disconnection and replacement of empty cylinders without interruption to the gas flow. The use of contact gauge (accessories) in conjunction with alarm box (accessories) facilitates the monitoring of gas reserves. The BMD 500-34 has an external gas purge, the BMD 500-35 an internal gas purge. Vent piping for connection to the relief valve (on type -34 included) can be ordered optionally for type -35.

APPLICATION

These gas supply panels, with semi-automatic switch over, are optimally used when it is when uninterrupted gas supply is required.

TECHNICAL DATA

Body:	stainless steel 316L (1.4404) specially cleaned and electro-polished or brass CW614 (CuZn39Pb3) specially cleaned, nickel-plated and chrome-plated
Relief valve:	Outlet NPT 1/4"f
Body seals:	PCTFE (SS), PVDF (Brass)
Seat seals:	PCTFE
Relief valve seat seals:	FKM, (EPDM, FFKM)*, EPDM, (FKM)*
Pressure gauge range:	-1 - 18 bar (-15 - 260 psi)/ 0 - 315 bar (0 - 4500 psi) 0 - 400 bar (0 - 5800 psi)
Dimensions (w×h×d):	approx. 400×155×200 mm
Weight:	approx. 5.5 kg (BMD 500-35)
Preset downstream pressure:	14 bar +/- 2 bar ; 200 +/- 30 psi
Flow rate:	25 Nm ³ /h N ₂ (14 bar - type at 29 bar inlet pressure.)
Purge inlet and outlet:	Tube fitting 6 mm (BMD 500-34)
Inlet:	NPT 1/4"f, M 14×1.5 (optional)
Outlet:	NPT 1/4"f, optional tube fitting

*on request

FLOW SCHEMATIC

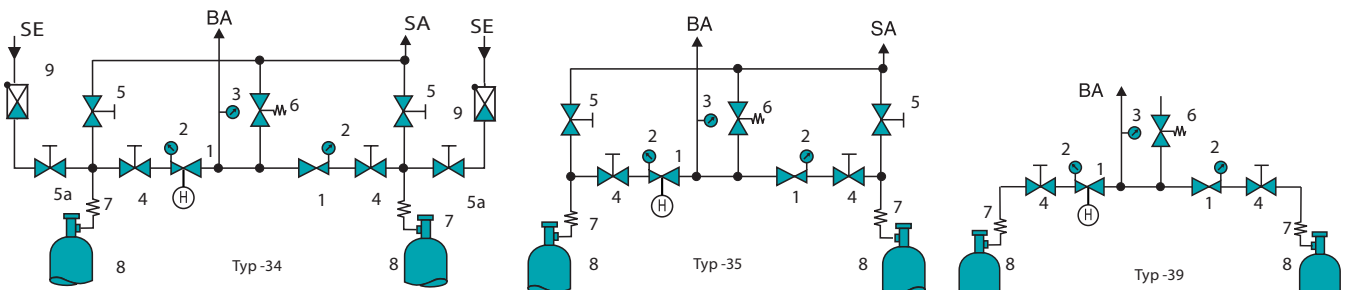

ORDER CODE

Type	Material	Upstream pressure	Downstream pressure	Inlet	Outlet	Contact gauge	Vent piping	Extension bar	Gas type
BMD 500-35	BC	F	14	N14	CL6 BC	Ki	A	M	GAS
BMD 500-34	BC = brass	F = 230 bar	14 = 14 bar/ 200 psi	N14 =	0=NPT 1/4"f	0 =	0 = without	0 = without	Please
BMD 500-35	chrome-plated	/3300 psi	50 = 50 bar	NPT 1/4"f	CL6, CL8**	without	A = with	M2 = 2×2	specify
BMD 500-39	SS = stainless	G = 315 bar	/720 psi	M14×1.5	CL10, CL12	Ki = with	(On type-35	Cylinder	
300 bar Versions:	steel	/4500 psi		(optional)	BC = brass		only in	M3 = 2×3	
BMD 530-34					chrome-plated		combination	Cylinder	
BMD 530-35							with RV)	M4 = 2×4	
BMD 530-39								Cylinder	

EXTENSION KITS MFOLD



**Extension kit,
for inert, corrosive, flammable and oxidizing gas and gas mixtures,
purity max. 6.0,
inlet pressure 315 bar / 4500 psi**

HIGHLIGHTS

- For 300 bar cylinders
- Cleaned for O2 service
- ATEX compliant
- Suitable for ECD service
- Modular concept

DESCRIPTION

Extension kit consist of a NPT inlets, SS bar and NPT outlet to manifold. Upon request it can be equipped with non return valves and/or shut off valves on inlet. The extension kit is designed for safe handling of high purity gases.

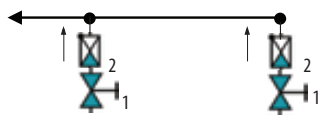

FLOW CHAT

- 1 Shut off valve
- 2 Non return valve

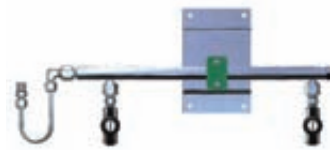

TECHNICAL DATA

Body material:	stainless steel 316L (1.4404) specially cleaned and electropolished
Weight:	approx. 1.2kg (NPT 1/4" f inlets)
Dimensions (w×h×d):	470×70×200 mm (with 2 inlets)
Inlet:	NPT 1/4" f
Outlet:	NPT 1/4" m

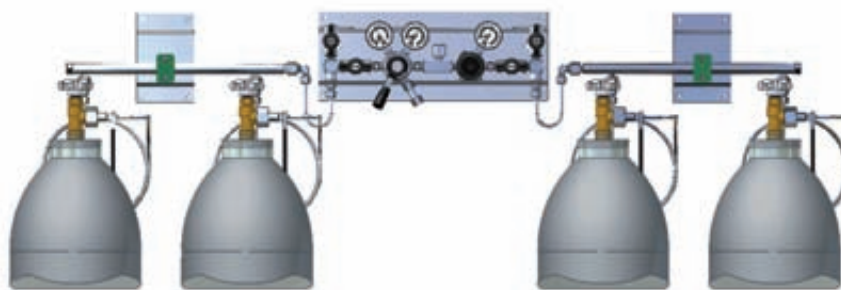
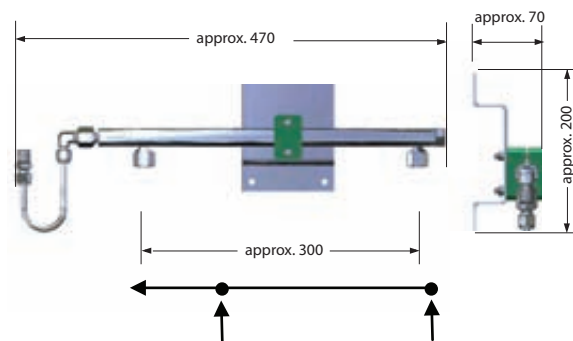

Installation example

ORDER CODE

Type	Material	Inlet Ports	Shut off Valve	Check Valve	Gas type
MFOLD	BC	2	MVA	CV	GAS
	SS=stainless steel BC = brass*)) Shut off valve material	2=2 inlets 3=3 inlets 4=4 inlets	0 = no valve MVA = with valve	0 = no CV CV= CV on each inlet	

POINT-OF-USE REGULATORS EMD 500/510-06



FLOW SCHEMATIC

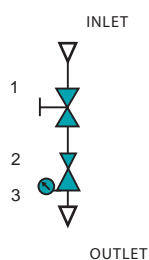

- 1 Upstream shut-off valve
- 2 Pressure regulator
- 3 Downstream gauge
- 4 Relief valve

**Single-stage,
for inert, reactive, flammable and oxidizing gases
and gas mixtures,
purity max. 6.0,
inlet pressure:**

**40 bar/ 600 psi /EMD 500
12 bar/ 175 psi /EMD 510**

downstream pressure range:

**EMD 500: 0.2 bar - 10.5 bar / 3 psi - 85 psi,
EMD 510: 0.2 bar abs. - 3 bar / 3 psi abs. - 45 psi.**

SPECIAL FEATURES

- Upstream valve with 90°-shut-off function
- Clear open/closed indicator for shut-off valves

DESCRIPTION

The EMD 500-06 consists of an upstream shut-off valve, pressure regulator, downstream gauges and Aluminium panel for wall mounting. A relief valve can be ordered as an optional extra.

APPLICATION

The EMD 500/510-06 is designed as an access point to a central gas supply system and thereby designed as a second stage, whereby the line pressure of apparatuses up to 0.2 bar absolute can be regulated downward. The EMD 510 is also suitable for sub-atmospheric pressure regulation.

TECHNICAL DATA

Body:	stainless steel 316L (1.4404) specially cleaned and electro-polished or brass CW614 (CuZn39Pb3) specially cleaned, nickel-plated and chrome-plated
Seat seals:	PTFE
Body seals:	PCTFE (SS), PVDF (Brass)
Performance data:	see chapter 5
Basic design aspects:	see page 13
Pressure gauge range:	0 - 1.5 bar (0 - 40 psi) 0 - 5 bar (0 - 75 psi) 0 - 10 bar (0 - 145 psi) 0 - 18 bar (0 - 260 psi)
Weight:	approx. 1.95 kg
Dimensions (wxhxd):	approx. 90x260x135 mm
Inlet/Outlet:	NPT 1/4" f, optional tube fitting

ORDER CODE

Type	Material	Upstream pressure	Downstream pressure	Inlet	Outlet	Relief Valve	Gas type
EMD 500-06	BC	E	1	CL6 BC	CL6 BC	RV	GAS
EMD 500-06	BC = brass	EMD 500-06:	EMD 500-06:	0=NPT 1/4" f	0=NPT 1/4" f	0 = without	Please
EMD 510-06	chrome-plated SS = stainless steel	E = 40 bar /600 psi EMD 510-06: D =12 bar / 175 psi	1 = 0.2 - 1 bar/3 -15 psi 6 = 0.5 - 6 bar/7 - 85 psi 10 = 1 - 10.5 bar/ 15 - 145 psi EMD 510-06: 2 = 0.2 - 2 bar abs./3 - 30 psi abs. 3 = 0.2 - 3 bar abs./3 - 45 psi abs.	CL6, CL8* CL10, CL12 BC = brass chrome-plated SS = stainless steel	CL6, CL8* CL10, CL12 BC = brass chrome-plated SS = stainless steel	A = with	specify

PURGE BLOCK DPB 500

For pure gases and gas mixtures, no oxygen,
purity max. 6.0,
2- or 3-port version,
for manual purging,
nominal pressure 230 bar / 3300 psi

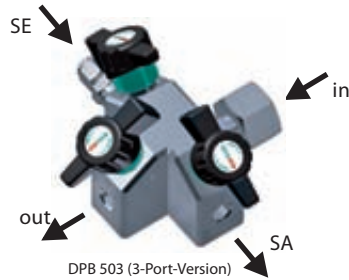

DPB 503 (3-Port-Version)

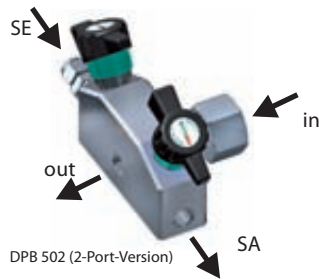
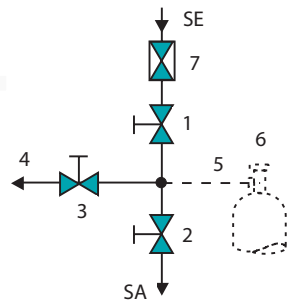

DPB 502 (2-Port-Version)

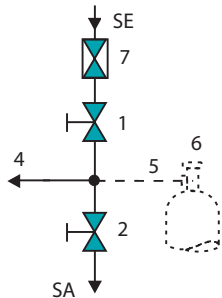

- 1 Purge gas inlet shut-off valve
- 2 Purge gas outlet shut-off valve
- 3 Shut-off valve
- 4 Process gas outlet
- 5 Cylinder connection
- 6 Gas cylinder
- 7 Check valve
- SE Purge inlet
- SA Purge outlet

SPECIAL FEATURES

- Maintaining gas purity near to the gas source
- No contact between the process gas and the ambient air
- Quick operation of shut-off valve with only quarter turn
- Clearly visible open/closed position
- Optimum purge conditions
- Wide range of applications
- Inlet- and outlet filters

DESCRIPTION

The 2-Port-purge block consists of a cylinder connection, check valve, purge gas inlet and purge gas outlet shut-off valves. The 3-Port-configuration also includes a process gas shut-off valve. The regular routine surface cleansing and ensuing quality control minimises the potential of contamination. The orbital welded connection fittings are optional and longer cylinder connections (100 mm) can also be offered as an alternative to standard.

APPLICATION

The triple valve block is used for external gas purging of high purity or corrosive gases and ensures continued of gas purity during the cylinder switch over. This purge unit guarantees the necessary safety when toxic gases are used. The benefit of these purge blocks with its wide range of applications lies in the optimum safety for the application and for the operator.

TECHNICAL DATA

Body:	Stainless steel 1.4404 specially cleaned
Diaphragm:	Hastelloy, Elgiloy
Body seals:	PCTFE
Performance data:	comparable to MVA 500 shut-off valve, chapter 5
Nominal width:	DN 5
KV-value:	0.15
Weight:	approx. 1.0 kg (2-port), 1.4 kg (3-port)
Dimensions:	DPB 502: approx. 80×90×150 mm DPB 503: approx. 120×90×150 mm
Inlet- and outlet filters:	100 µm mesh
Purge gas inlet:	check valve, tube fitting 6 mm
Purge gas outlet:	NPT 1/4"f, optional tube fitting
Inlet:	Cylinder connection DIN 477 longer cylinder connections optional
Outlet:	NPT 1/4"f, optional tube fitting

ORDER CODE

Type	Material	Upstream pressure	Inlet	Outlet	Gas type
DPB-503	SS	F	DIN	CL6	GAS
DPB-503	SS = stainless steel	F = 230 bar/3300 psi	DIN	0=NPT 1/4"f	Please specify
DPB-502	BC = brass chrome-plated (DPB-02 only)		ANSI AFNOR NBN BS 341 CGA NEN UNI	CL6* CL8 CL10 CL12	(no O2)

PRESSURE REGULATORS SERIES 320

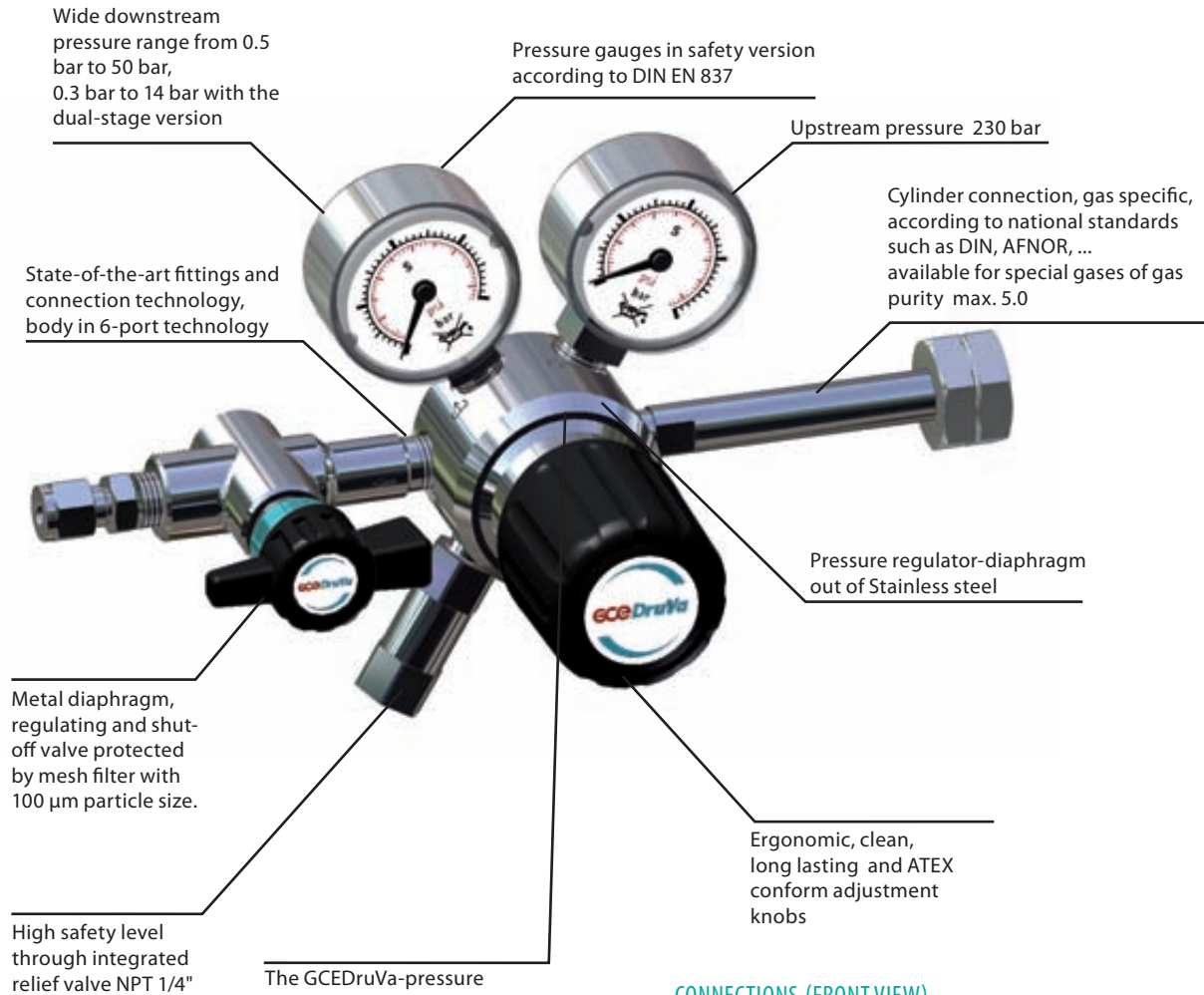

Wide downstream pressure range from 0.5 bar to 50 bar, 0.3 bar to 14 bar with the dual-stage version

Pressure gauges in safety version according to DIN EN 837

Upstream pressure 230 bar

Cylinder connection, gas specific, according to national standards such as DIN, AFNOR, ... available for special gases of gas purity max. 5.0

State-of-the-art fittings and connection technology, body in 6-port technology

Pressure regulator-diaphragm out of Stainless steel

Metal diaphragm, regulating and shut-off valve protected by mesh filter with 100 µm particle size.

Ergonomic, clean, long lasting and ATEX conform adjustment knobs

High safety level through integrated relief valve NPT 1/4"

The GCEdruVa-pressure regulating unit guarantees easy maintenance and service with integrated particle filters 10 µm particle size. Cleanness and leak tightness fulfilling the demands of high purity applications.

CONNECTIONS (FRONT VIEW)

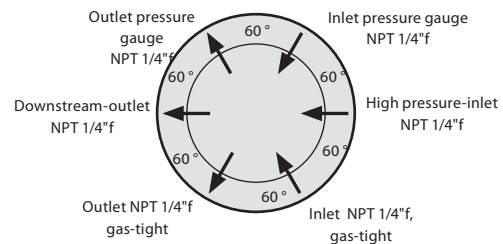

BASIC DESIGN ASPECTS*

MATERIAL

Body: stainless steel 316L (1.4404) specially cleaned or brass CW614 (CuZn39Pb3) nickel-plated and chrome-plated.

SEALING MATERIAL

PCTFE, PTFE, FKM etc., dependent upon gas specification and purity requirements. Material is specified in "Technical data".

INNER PARTS

Low maintenance, service friendly regulator unit, with a 10 µm particle filter on inlet and 100 µm on the outlet.

DIAPHRAGM

The stainless steel material offers ample protection against damage and corrosion.

PERFORMANCE DATA

See performance charts in section 5, for differing pressure ranges please contact GCE GmbH.

GUARANTEED LEAKAGE RATES

< 1×10⁻⁹ mbar l/s Helium (outboard).
< 1×10⁻⁶ mbar l/s Helium (across the seat).

WORKING TEMPERATURE

-25 °C to +70 °C / -13 °F to 158 °F

PURITY

≤ 5.0

CYLINDER CONNECTIONS

In accordance with German national standards DIN 477. Other connections such as US-Norm CGA, British Standard BS etc. are available.

*Data other than that given for the Series 320 can be found listed in the "Technical Data" of the individual pressure regulator.

CYLINDER PRESSURE REGULATORS FMD 320-14/-16/-18



**Single-stage,
for inert, reactive and oxidizing gases and mixtures, no acetylene,
purity max.5.0,
cylinder pressure 230 bar / 3300 psi,
downstream pressure range 0.5 - 50 bar / 7 - 720 psi.**

SPECIAL FEATURES

- Diaphragm valve (FMD 320-16 with 90°-shut-off function)
- Pressure regulator with stainless steel diaphragm
- ATEX conform adjustment knob
- Gauge in safety version accordance with DIN EN 837

DESCRIPTION

These pressure regulators consist of cylinder connections, pressure regulator, inlet- and outlet gauges, diaphragm shut-off valve (Type -16) regulating valve (Type -18), relief valve, tube fitting on outlet.

APPLICATION

The FMD 320-14 is the base model. The FMD 320-16 permits shutting-off of the gas flow while maintaining the pressure regulator settings, the regulating valve on the FMD 320-18 enables a fine apportioning of the gas flow.

TECHNICAL DATA

Body:	Stainless steel 316L (1.4404) specially cleaned or Brass CW614 (CuZn39Pb3) specially cleaned
Seat seals:	PCTFE
Body seals:	PCTFE (Stainless steel), PVDF (Brass)
Diaphragm:	Stainless steel
Leakage rate:	< 1×10 ⁻⁹ mbar l/s Helium (outboard) < 1×10 ⁻⁶ mbar l/s Helium (across the seat)
Relief valve seat seals:	SS: FKM, (EPDM*, FFKM*), Brass: EPDM, (FKM*)
Pressure gauge range:	0 to 25 bar (0 - 365 psi), 0 - 80 bar (0 - 1150 psi), 0 - 315 bar (0 - 4500 psi)
Working temperature:	-25 °C to +70 °C / -13 °F to 158 °F
Weight:	approx. 1.5 kg (Type -14), 1.8 kg (Type -16/18)
Performance data:	see chapter 5
Basic design aspects:	see page 40
Cylinder connection:	according to gas type
Outlet:	NPT 1/4" f, optional tube fitting

*on request

DIMENSIONS

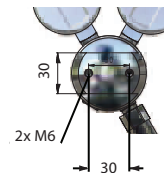
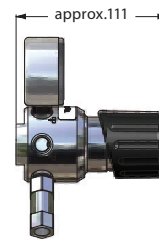

FLOW SCHEMATIC

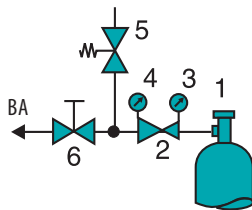

- 1 Cylinder connection
 - 2 Pressure regulator
 - 3 Upstream pressure gauge
 - 4 Downstream pressure gauge
 - 5 Relief valve
 - 6 Downstream shut-off valve (only type -16) / regulating valve (only type -18)
- BA Process gas outlet

ORDER CODE

Type	Material	Upstream pressure	Downstream pressure	Inlet	Outlet	Gas type
FMD 320-14	B	F	6	DIN	CL6	GAS
FMD 320-14	B = brass	F = 230 bar	6 = 0.5 - 6 bar / 15 - 200 psi	DIN	0=NPT 1/4" f	Please specify
FMD 320-16	SS = stainless steel	/3300 psi	14 = 1 - 14 bar / 15 - 200 psi	ANSI/ AFNOR/ NBN/BS 341/ CGA/NEN/UNI	CL6/ CL8**	
FMD 320-18	steel				CL 1/8" /CL 1/4" NO6	

CYLINDER PRESSURE REGULATORS FMD 322-14/-16/-18

**Dual-stage,
for inert, reactive, flammable and oxidizing gases and mixtures,
not suitable for acetylene,
purity max. 5.0
cylinder pressure 230 bar / 3300 psi,
downstream pressure range 0.5 - 10.5 bar / 7 - 150 psi**

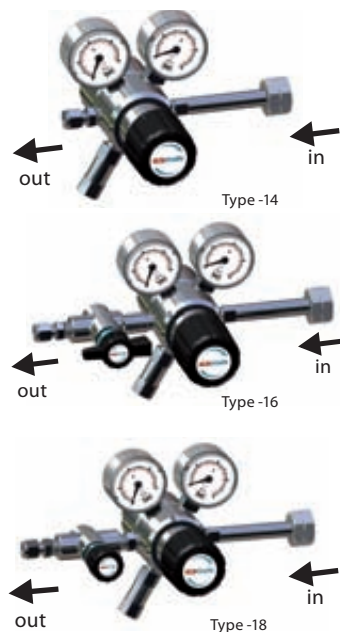

SPECIAL FEATURES

- Downstream pressure is independent of the upstream pressure due to the dual-stage design
- Diaphragm valve (FMD 322-16 with 90° shut-off function)
- Pressure regulator with stainless steel diaphragm
- ATEX conform adjustment knob
- Gauge in safety version accordance with DIN EN 837

DESCRIPTION

These pressure regulators consist of cylinder connections, pressure regulator, inlet- and outlet gauges, diaphragm shut-off valve (Type -16) regulating valve (Type -18), relief valve, tube fitting on outlet.

APPLICATION

The FMD 322-14 is the base model. The FMD 322-16 permits shutting-off of the gas flow while maintaining the pressure regulator settings, the regulating valve on the FMD 322-18 enables a fine controlling of the gas flow. The dual-stage pressure regulator ensures the uniformity of the downstream pressure independent of the level of the cylinder pressure.

TECHNICAL DATA

Body:	Stainless steel 316L (1.4404) specially cleaned or Brass CW614 (CuZn39Pb3) specially cleaned
Seat seals:	1st stage: PCTFE, 2nd stage: PTFE
Body seals:	PCTFE (Stainless steel), PVDF (Brass)
Diaphragm:	Stainless steel
Leakage rate:	< 1×10 ⁻⁹ mbar l/s Helium (outboard) < 1×10 ⁻⁶ mbar l/s Helium (across the seat)
Relief valve seat seals:	Stainless steel: FKM, (EPDM, FFKM) * Brass: EPDM, (FKM)
Pressure gauge range:	-1 to 10 bar (-15 to 145 psi), -1 to 18 bar (-15 to 260 psi), 0 - 315 bar (0 - 4500 psi)
Weight:	approx. 2.1 kg (Type -14), 2.4 kg (Type -16/18)
Working temperature:	-25 °C to +70 °C / -13 °F to 158 °F
Performance data:	see chapter 5
Basic design aspects:	see page 40
Cylinder connection:	according to gas type

*on request

FLOW SCHEMATIC

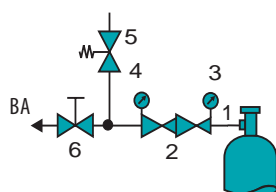

- 1 Cylinder connection
 - 2 Dual-stage pressure regulator
 - 3 Upstream pressure gauge
 - 4 Downstream pressure gauge
 - 5 Relief valve
 - 6 Downstream shut-off valve (only type -16)
/ downstream regulating valve (only type -18)
- BA Process gas outlet

DIMENSIONS

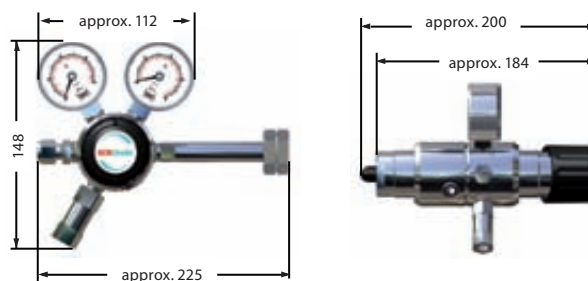

ORDER CODE

Type	Material	Upstream pressure	Downstream pressure	Inlet	Outlet	Gas type
FMD 322-14	B	F	6	DIN	CL6	GAS
FMD 322-14	B = brass	F = 230 bar	6 = 0.5 - 6 bar / 7 - 85 psi	DIN	0=NPT 1/4"f	Please
FMD 322-16	SS = stainless steel	/3300 psi	10 = 1 - 10.5 bar / 15 - 150 psi	ANSI/ AFNOR/ NBN/BS 341/ CGA/NEN/UNI	CL6/ CL8** CL 1/8" /CL 1/4"	specify
FMD 322-18					NO6	

CYLINDER PRESSURE REGULATORS FMD 300-14/-18, FMD 302-14/-18

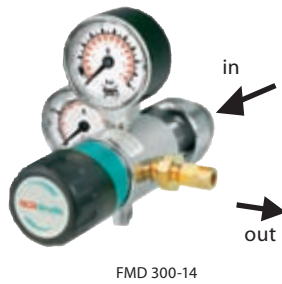

FMD 300-14

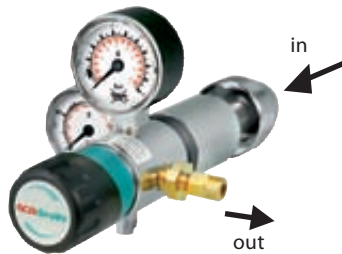

FMD 302-14

**Single-stage / dual-stage,
for inert gases and gas mixtures and oxygen,
purity to 5.0,
cylinder pressure 230 bar
downstream pressure range 0.2 - 12 bar / 3- 175 psi**

SPECIAL FEATURES

- Clear position indicator
- Easy to operate
- Inlet on back side
- Integrated relief valve
- Diaphragm material Hastelloy
- Seat seals in PCTFE
- FMD 300/302-18: with regulating valve
- Constant downstream pressure though dual-stage design (Type 302)

DESCRIPTION

The FMD 300-14 consists of manual cylinder connection with knurled nut (supplied), pressure regulator, upstream pressure gauge, downstream pressure gauge, relief valve and screw connections. The FMD 300/302-18 has in addition a regulating valve at the outlet. The customary hose fittings and couplings are available as accessories (see ordering information). The inlet on the back end allows for particularly space saving installation. The dual-stage FMD 302 is deployed where ever high pressure consistency is needed.

APPLICATION

The cylinder pressure regulator series FMD 300/302 is attractive for its high flow rate values and good regulating characteristics. The FMD 300-14 is used anywhere where gas is directly taken from the cylinder and greater flexibility for the end user when choosing a location for use.

FLOW SCHEMATIC

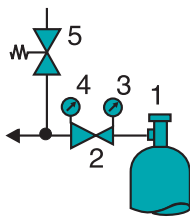

FMD 300-14

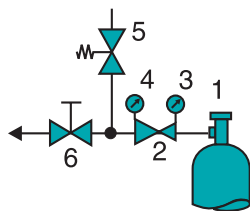

FMD 300-18

- 1 Cylinder connection
- 2 Pressure regulator (FMD 302 dual-stage)
- 3 Upstream pressure gauge
- 4 Downstream pressure gauge
- 5 Relief valve
- 6 Downstream regulating valve (Type -18)

TECHNICAL DATA

Body:	Brass, 2.0401.26 specially cleaned, nickel-plated and chrome-plated
Seat seals:	PCTFE (FMD 302 PCTFE, PTFE)
Relief valve:	triggered at 1.4- to 1.8- times nominal pressure
Purity:	≤ 5.0
Leakage rate:	< 1×10 ⁻⁷ mbar l/s Helium (outboard)
	< 1×10 ⁻⁶ mbar l/s Helium (across the seat)
Working temperature:	-25 °C to +70 °C / -13 °F to 158 °F
Filter at inlet:	50 µm
Weight:	approx. 1.12 kg (FMD 300-14) / 1.34 kg (FMD 300-18)
	approx. 1.68 kg (FMD 302-14) / 1.89 kg (FMD 302-18)
Dimensions (w×h×d):	approx. 140×120×115 mm (FMD 300 without cylinder connection)
	approx. 140×120×180 mm (FMD 302 without cylinder connection)
Gauge:	0 - 3, 0 - 10, 0 - 16 bar and 0 - 315 bar
Performance data:	see chapter 5
Inlet:	Cylinder connection as per DIN 477, see chapter 5
Outlet:	Tube fitting 6 mm (standard)

ORDER CODE

Type	Material	Upstream pressure	Downstream pressure connection	Cylinder-	Outlet	Gas type
FMD 300-14	BC	F	C	DIN	CL6	GAS
FMD 300-14	BC = brass	F = 230	C = 1 - 6 bar	DIN	CL3*	Please
FMD 300-18			D = 1 - 12 bar		CL6	specify
FMD 302-14			FMD 302:		CL 1/8"	
FMD 302-18			B = 0.2 - 2 bar		NO4	
			C = 0.5 - 6 bar		N08	

GAS PANELS DGS 0 / DGS 1

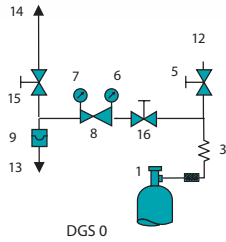

- | | |
|-----------------------|--------------------------------------|
| 1 Cylinder valve | 13 Rupture disc outlet |
| 3 Cylinder connection | 14 Process gas outlet |
| 5 Purge outlet valve | 15 Process gas outlet shut-off valve |
| 6 Inlet gauge | 16 Process gas inlet shut-off valve |
| 7 Outlet gauge | |
| 8 Pressure regulator | |
| 9 Rupture disc | |
| 12 Purge outlet | |

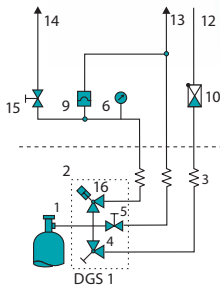

- | | |
|-----------------------|--------------------------------------|
| 1 Cylinder valve | 10 Check valve |
| 2 Purge valve block | 12 Purge outlet |
| 3 Cylinder connection | 13 Rupture disc outlet |
| 4 Purge inlet valve | 14 Process gas outlet |
| 5 Purge outlet valve | 15 Process gas outlet shut-off valve |
| 6 Inlet gauge | 16 Process gas inlet shut-off valve |
| 9 Rupture disc | |

ORDER CODE

Type Gas type
DGS 0 **GAS**
 DGS 0 Please specify
 DGS 1

Single-stage, for low flow of non corrosive special gases, purity max. 7.0, inlet pressure 230 bar / 3300 psi, adjustable downstream pressure 0.7 - 7 bar / 2 - 100 psi

SPECIAL FEATURES DGS 0

- Process gas purging
- All connections welded or VCR
- Pressure regulator with tied diaphragm
- Springless diaphragm valve with 90° turn lever
- Rupture disc limits max. pressure
- Safety gauge RM 63
- Pressure regulator and valve material 316L/AOD/VAR

DESCRIPTION

This single-stage gas supply panel is mounted onto a stainless steel console and consists of a pressure regulator with inlet and outlet pressure gauges, shut-off valve and rupture disk.

APPLICATION

These gas supply panels are used for low flow rates of high purity gases and special gases.

TECHNICAL DATA

Flow rate data Cv:	Pressure regulator 0.09, valve 0.29
Diaphragm:	316L
Seat:	PCTFE
Process gas outlet:	VCR 1/4"m
Purge outlet:	VCR 1/4"f
Working temperature:	-40 °C to +70 °C / 40 °F to 158 °F
Surface finish:	0.4 µm / 15 µin. Ra max. standard
Outboard leakage:	2×10 ⁻⁹ cm ³ /sec He by 100 bar/1500 psig
Seat leakage:	4×10 ⁻⁸ cm ³ /sec He by 70 bar/1000 psig

For special gases, purity max. 7.0, inlet pressure vacuum to 17 bar / 250 psi, downstream pressure vacuum to inlet pressure

SPECIAL FEATURES DGS 1

- For low flow rates and low downstream pressures
- External gas purging with FAV 903
- Springless diaphragm valve with 90° turn lever
- Rupture disc limits max. pressure
- Valve material 316L/AOD/VAR

DESCRIPTION

This single-stage gas supply panel is mounted onto a stainless steel console and consists of a gauge, shut-off valve and rupture disk. The gas stock is connected via a purgeable cylinder valve so that the station can be purged with external gas.

APPLICATION

These gas supply panels are used for low flow rates of high purity gases and special gases.

TECHNICAL DATA

Flow rate data Cv:	Valve 0.5
Seat :	PCTFE
Diaphragm:	Elgiloy
Inlet/Outlet:	VCR 1/4"m
Working temperature:	-40 °C to +70 °C / 40 °F - 158 °F
Surface finish:	0.4 µm / 15 µin. Ra max. standard
Outboard leakage:	2×10 ⁻⁹ cm ³ /sec He by 17 bar/250 psig
Seat leakage:	4×10 ⁻⁸ cm ³ /sec He by 17 bar/250 psig

GAS PANELS DGS 2 / DGS 3



Single-stage, with external gas purging, for low flow rates reactive and corrosive special gases, purity max. 7.0, inlet pressure 230 bar / 3300 psi, adjustable downstream pressure 0.15 - 10 bar / 2 - 145 psi

SPECIAL FEATURES DGS 2

- Pressure regulator with tied diaphragm
- Springless diaphragm valve with 90° turn lever
- Rupture disc limits max. pressure
- Safety gauge RM 63
- Pressure regulator and valve material 316L/AOD/VAR

DESCRIPTION

This single-stage gas supply panel is mounted onto a stainless steel console and consists of a pressure regulator with inlet and outlet pressure gauges, downstream shut-off valve and rupture disk. The gas stock is connected via a purgeable cylinder valve so that the station can be purged with inert gas.

APPLICATION

These gas supply panels are used for low flow rates by low pressure for reactive or corrosive gases.

TECHNICAL DATA

Flow rate data Cv:	Pressure regulator 0.09, valve 0.29
Seat:	PCTFE
Diaphragm:	Hastelloy C22
Process gas outlet:	VCR 1/4"f
Purge inlet + outlet:	VCR 1/4"m
Working temperature:	-40 °C to +70 °C / 40 °F - 158 °F
Surface finish:	0.4 µm / 15 µin. Ra max. standard
Outboard leakage:	2×10 ⁻⁹ cm ³ /sec He by 100 bar/1500 psig inlet pressure
Seat leakage:	4×10 ⁻⁸ cm ³ /sec He by 70 bar/1000 psig inlet pressure

FLOW SCHEMATIC

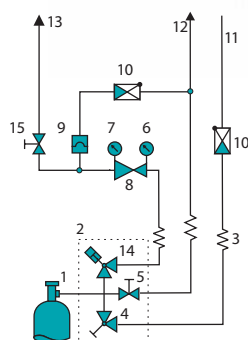

- | | |
|-----------------------|--------------------------------------|
| 1 Process gas inlet | 12 Purge outlet |
| 2 Purge valve block | 13 Process gas outlet |
| 3 Cylinder connection | 14 Process gas inlet shut-off valve |
| 4 Purge inlet valve | 15 Process gas outlet shut-off valve |
| 5 Purge outlet valve | 16 Vacuum generator valve |
| 6 Inlet gauge | 17 Vacuum generator valve |
| 7 Outlet gauge | |
| 8 Pressure regulator | |
| 9 Rupture disc | |
| 10 Check valve | |
| 11 Purge inlet | |

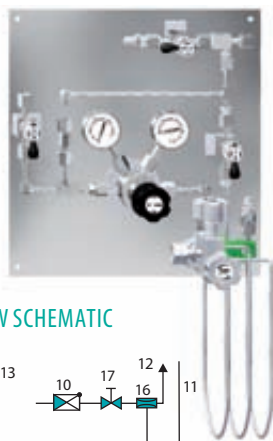

Single-stage, with external gas purging, for special gases, purity max. 7.0, inlet pressure 230 bar / 3300 psi, adjustable downstream pressure 0.15 - 10 bar / 2 - 145 psi

SPECIAL FEATURES DGS 3

- External gas purging with FAV 903 and vacuum generation with VG 80
- Pressure regulator with tied diaphragm
- Springless diaphragm valve with 90° turn lever
- Rupture disc limits max. pressure
- Safety gauge RM 63
- Pressure regulator and valve material 316L/AOD/VAR

DESCRIPTION

This single-stage gas supply panel is mounted onto a stainless steel console and consists of a pressure regulator with inlet and outlet pressure gauges, downstream shut-off valve and burst disk. The gas stock is connected via a purgeable cylinder valve so that with the help a vacuum generator the station can be purged extremely effectively with inert gas.

APPLICATION

These gas supply panels are used for low flow rates of high purity, reactive corrosive gases and special gases.

TECHNICAL DATA

Flow rate data Cv:	Pressure regulator 0.09, valve 0.29
Seat:	PCTFE
Diaphragm:	Hastelloy C22
Process gas outlet/ Purge inlet:	VCR 1/4"m
Vacuum generator:	Outlet: VCR 1/4"m, inlet: VCR or tube welded
Working temperature:	-40 °C to +70 °C / 40 °F - 158 °F
Surface finish:	0.4 µm / 15 µin. Ra max. standard
Outboard leakage:	2×10 ⁻⁹ cm ³ /sec He by 100 bar/1500 psig Inlet pressure
Seat leakage:	4×10 ⁻⁸ cm ³ /sec He by 70 bar/1000 psig Inlet pressure

FLOW SCHEMATIC

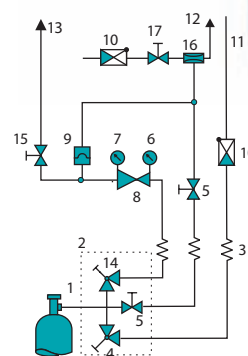

ORDER CODE

Type	Gas type
DGS 2	GAS
DGS 2	Please specify
DGS 3	

GAS PANELS BMD/SMD 200-29

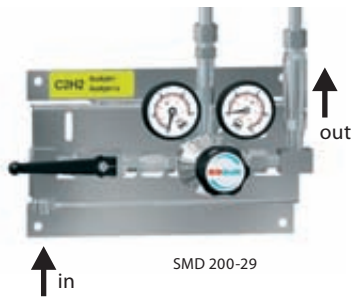

**Single-stage,
for acetylene average purity,
inlet pressure 25 bar
downstream pressure approx. 1.5 bar**

SPECIAL FEATURES

- Single-stage version for conventional gas usages
- Gas failure monitoring via contact gauges and signal boxes (optional)
- Single components with type approval
- Connections for 1 or 2x1 cylinders
- AAS suitable (Atomic Absorption Spectrometer)

DESCRIPTION

Station with inlet ball valve, upstream and downstream pressure gauges, relief valve, flashback arrestor and connections for 1 cylinder (SMD) or 2 cylinders (BMD).

APPLICATION

As first stage of a central gas supply. This gas supply panel together with contact gauge and signal box ensures an uninterrupted gas supply. The switch-over from the empty cylinder to the full supply cylinder is operated manually. The use of contact gauge (accessories) in conjunction with alarm box (accessories) facilitates the monitoring of gas reserves.

TECHNICAL DATA

Upstream pressure:	25 bar
Downstream pressure:	approx. 1.5 bar
Body:	Brass 2.0401.26
Diaphragm:	Rubber
Flow rate:	to 11 m ³ /h (pa = 1.26 bar)
Working temperature:	-20 to +60 °C / -4 to 140 °F
Dimensions (w×h×d):	approx. 300×155×160 mm
Weight:	approx. 4.6/5.5 kg (SMD / BMD)
Performance data:	see chapter 5
Inlet gauge:	contact gauge (optional)
Pressure gauge range:	0 - 40 bar, 0 - 580 psi (inlet), 0 - 2.5 bar, 0 - 36 psi (outlet)
Relief valve outlet:	Tube Ø 12 mm
Safety feature:	Flashback arrestor GVA G3/8" lh
Inlet:	W21,8×1/14"
Outlet:	Tube Ø 12 mm×7 mm

FLOW SCHEMATIC

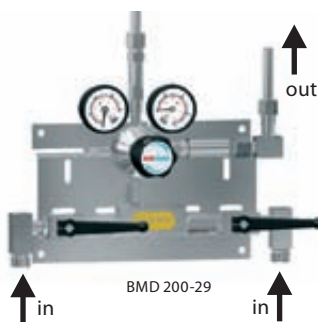
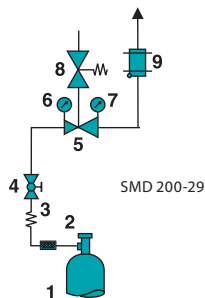

FLOW SCHEMATIC

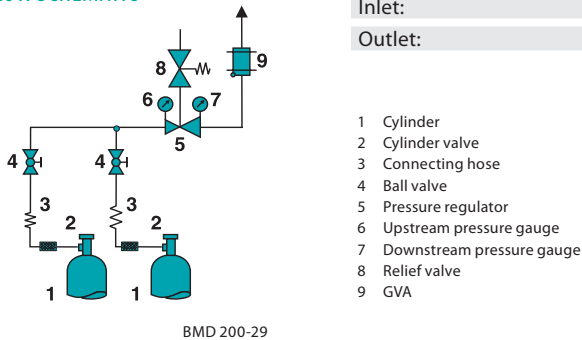

- 1 Cylinder
- 2 Cylinder valve
- 3 Connecting hose
- 4 Ball valve
- 5 Pressure regulator
- 6 Upstream pressure gauge
- 7 Downstream pressure gauge
- 8 Relief valve
- 9 GVA

ORDER CODE

Type	Material	Downstream pressure	Inlet	Outlet	Contact gauge	Gas type
SMD 200-29	BC	1.5	DIN*	12	Ki	GAS
SMD 200-29	BC = brass	1.5 = 1.5 bar/22 psi	DIN, ANSI	12 = Tube with 12 mm	0 = without	C2H2
BMD 200-29	chrome-plated		AFNOR, NBN BS 341, CGA NEN, UNI	outside diameter, inside diameter 7 mm	Ki = with	

SEMI-AUTOMATIC SWITCH-OVER ACETYLENE BMD 202-39

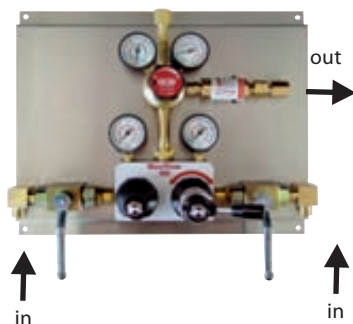

**Dual-stage,
for average purity acetylene,
inlet pressure 25 bar,
downstream pressure 1.5 bar**

SPECIAL FEATURES

- Uninterrupted gas supply with semi-automatic switch over
- High flow rate
- Low supply pressure alarm (optional)
- Connections for 6 cylinders
- AAS suitable (Atomic Absorption Spectrometer)

DESCRIPTION

The gas supply panel BMD 202-39 guarantees an uninterrupted acetylene supply through the automatic switch-over from the empty side to the full reserve side. This pressure regulating station is approved for the connection of maximum 6 cylinders. A flashback arrestor is installed on the outlet side. The use of contact gauge (accessories) in conjunction with alarm box (accessories) facilitates the monitoring of gas reserves. The station is mounted on a stainless steel plate and equipped with stainless steel fittings on the outlet side (optional).

APPLICATION

This gas supply panel is deployed where large amounts of acetylene are used and where the gas flow cannot be interrupted.

TECHNICAL DATA

Upstream pressure:	25 bar
Downstream pressure, max.:	approx. 1.5 bar
Average switch over pressure:	approx. 4 bar
Reserve pressure:	approx. 3 bar
Flow rate:	7.5 m ³ /h
Upstream pressure gauge:	2 gauges (40 bar) in accordance EN 562 (2 contact gauges Ki 63-40/11 optional), 1 gauge (40 bar) in accordance EN 562
Downstream pressure gauge:	(2.5 bar) in accordance EN 562
Shut-off valve:	ball valve 3/8"
Working temperature:	-25° to 70°C / -13 °F to 158 °F
Safety feature:	Flashback arrestor GVA G3/8" LH
Relief valve outlet:	NPT 1/4" f
Inlet:	W21,8x1/14"
Outlet:	NPT 1/4" f, optional tube fitting (SS)

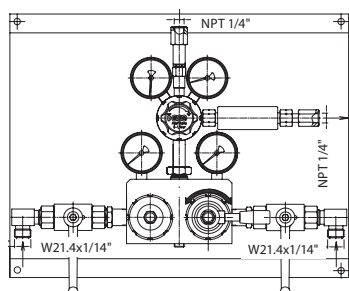

ORDER CODE

Type	Material	Downstream pressure	Inlet	Outlet	Contact gauge	Gas type
BMD 202-39	B	1.5	DIN*	CL8 SS	Ki	GAS
BMD 202-39	B = brass	1.5 = 1.5 bar /22 psi	DIN, ANSI AFNOR, NBN BS 341, CGA NEN, UNI	0 = without, CL6, CL8, CL10, CL12* Material Stainless steel (SS)	0 = without Ki = with	C2H2

PROPANE GAS PANELS



Single cylinder station

**Single or double cylinder stations,
for propane gas cylinders up to 33 kg,
inlet pressure 1 - 16 bar
downstream pressure 50 mbar**

SPECIAL FEATURES

- Individual parts DIN-DVGW tested
- Double cylinder station with semi-automatic switch-over valve
- Low gas pressure alarm (optional)

DESCRIPTION

The single cylinder station consists of a low pressure regulator, 400 mm medium pressure hose with a safety shut-off valve and a safety relief valve. The double cylinder station consists of a low pressure regulator, a safety shut-off valve (connected upstream) and safety relief valve, 2 high pressure hoses with cylinder connections, a support rail, semi-automatic switch-over valve PN 16, the extraction is rotationally achieved. Both stations conform to the requirements of the TRF 1996 and/or the BGV D 34§11 para. 4.



Double cylinder station
fully mounted



Propane hose

TECHNICAL DATA

Upstream pressure:	16 bar
Downstream pressure:	0.05 bar
Flow rate:	max. 4 kg/h
Inlet:	Single cylinder station: cylinder connection
Double cylinder station:	hose
Outlet:	Single cylinder station: medium pressure hose
Double cylinder station:	hose connection tube Ø 12 mm

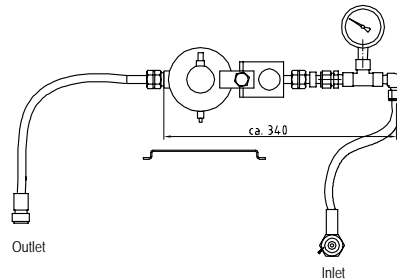

Example configuration: single cylinder station
with contact gauges

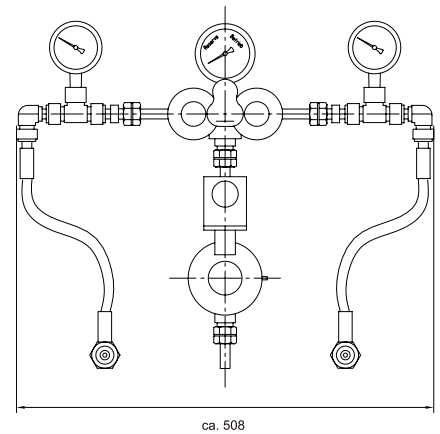

Example configuration: double cylinder station
with contact gauges

ORDER CODE

Type
SMD 090

SMD 090
BMD 092

Contact gauge
Ki

0 = without
Ki = with

DIAPHRAGM SHUT-OFF VALVES MVA 500/530

For inert, reactive, flammable and oxidizing gases and gas mixtures,

purity max. 6.0,

inlet pressure:

MVA 500: 230 bar/ 3300 psi

MVA 530: 315 bar /4500 psi

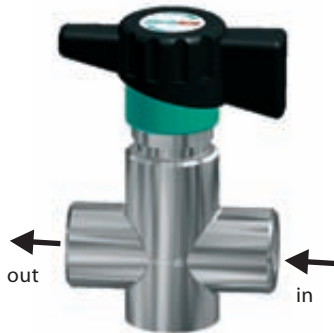

SPECIAL FEATURES

- Quick operation through 90° shut-off function
- Clearly visible open/closed position
- Increased lifespan through the fine adjustment of the closing pressure

DESCRIPTION

The diaphragm valve MVA 500 is characterized through its outstanding functional safety and high leak-tightness. The open/closed position on the valve is achieved through a 90°-turn of the handle (with a click into the end position).

APPLICATION

As a line shut-off in a centralized high purity gas supply. As a system component in high and low pressure areas.

MOUNTING

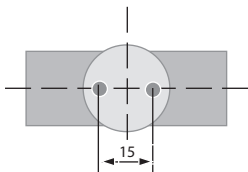

The MVA 500 has 2 bore holes M6 on the bottom.

TECHNICAL DATA

Body:	Stainless steel 1.4404 specially cleaned and electro-polished or brass
	CW614 (CuZn39Pb3) specially cleaned, nickel-plated and chrome-plated
Diaphragm:	Elgiloy
Body seals:	PCTFE
Leakage rate:	< 1×10 ⁻⁶ mbar l/s Helium (seats), < 1×10 ⁻⁹ mbar l/s Helium (outboard)
Dimensions (w×h×d):	approx. 53×77×40 mm
Nominal width:	DN 5
Working temperature:	-25° to 70°C / -13 °F to 158 °F
Kv-value:	0.25
Inlet/outlet filter:	100 µm mesh
Vacuum capable:	yes
Weight:	approx. 280 g

CROSS SECTION

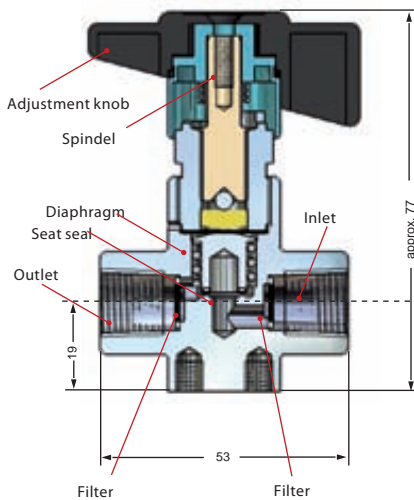

ORDER CODE

Type	Material	Inlet	Outlet	Gas type
MVA 500	BC	CL6 BC	CL6 BC	GAS
MVA 500	BC = brass	0=NPT 1/4"f	0=NPT 1/4"f	Please specify
MVA 530	chrome-plated	CL6*	CL6*	
	SS = stainless steel	CL8	CL8	
		CL10	CL10	
		CL12	CL12	
		BC = brass	BC = brass	
		SS = stainless steel	SS = stainless steel	

DIAPHRAGM REGULATING VALVES MVR-A 500 G

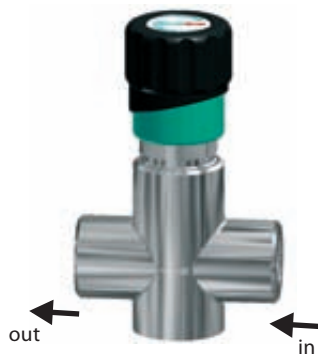

For inert, reactive, flammable and oxidizing gases and gas mixtures, purity max. 6.0, inlet pressure: 50 bar / 600 psi oxygen (O₂): 40 bar / 725 psi

SPECIAL FEATURES

- Very fine gas flow adjustment
- Wide flow rate range for high and low pressure applications
- Hardened stainless steel cone for a longer life span
- High leak tightness through appropriate diaphragm construction
- Very easily purged
- With shut-off function (leak tightness 1×10^{-6} mbar l/s Helium)

DESCRIPTION

The regulating valve MVR 500 has a very good regulating characteristic and is very finely adjustable both by greater as also by lesser flow rate values. Space saving through integrated shut-off function, since only one valve is required.

APPLICATION

As a system component in and low pressure areas. As accessory for cylinder and point-of-use regulators for fine adjustment of the gas flow. As system element in apparatus and analytical equipment.

MOUNTING

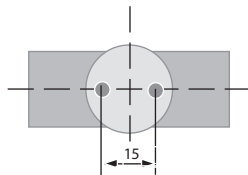

The valve has 2 bore holes M6 on the bottom.

CROSS SECTION

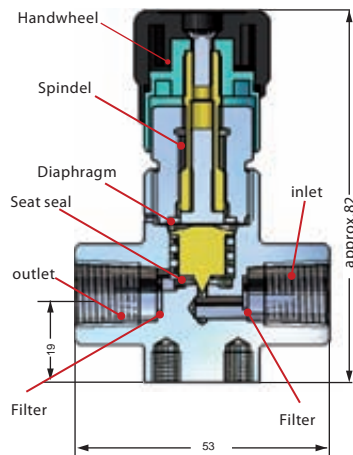

TECHNICAL DATA

Body:	Stainless steel 1.4404 specially cleaned and electro-polished or brass
	CW614 (CuZn39Pb3) specially cleaned, nickel-plated and chrome-plated
Body seals:	hardened stainless steel cone
Diaphragm:	Hastelloy
Leakage rate:	$< 1 \times 10^{-6}$ mbar l/s Helium (seat)
	$< 1 \times 10^{-9}$ mbar l/s Helium (outboard)
Nominal width:	DN 2
Dimensions (w×h×d):	approx. 53×82×40 mm
Working temperature:	-25° to 70°C / -13 °F to 158 °F
K _v -value:	< 0.02
Filter:	100 µm mesh on inlet and outlet
Vacuum capable:	yes
Operation:	adjustment knob with approx. 10 turns
Weight:	approx. 280 g
Inlet/Outlet:	NPT 1/4" f, optional tube fitting

ORDER CODE

Type	Material	Upstream pressure	Inlet	Outlet	Gas type
MVR-A 500 G	BC	E	CL6 BC	CL6 BC	GAS
MVR-A 500 G	BC = brass chrome-plated SS = stainless steel	E = 40 bar/600 psi oxygen (O ₂) E = 50 bar/725 psi	0=NPT 1/4" f CL6* CL8 CL10 CL12 BC = brass chrome-plated SS = stainless steel	0=NPT 1/4" f CL6* CL8 CL10 CL12 BC = brass chrome-plated SS = stainless steel	Please specify

DIAPHRAGM SHUT-OFF VALVES MVA 501 G

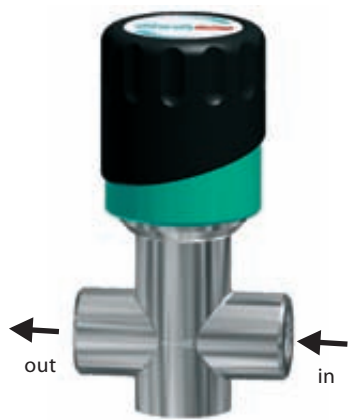

For inert, reactive, flammable and oxidizing gases and gas mixtures, purity max. 6.0, inlet pressure 40 bar / 600 psi

SPECIAL FEATURES

- Higher flow rates
- Leakage rate less than 1×10^{-8} mbar l/sec
- Gas wetted surfaces are specially cleaned and diffusion tight

DESCRIPTION

The diaphragm valve MVA 501 G with shut-off function, enables the easy shut-off of the gas flow with the turn of an adjustment knob.

APPLICATION

The valve is particularly suitable as system component for applications in low pressure areas for high gas flow.

MOUNTING

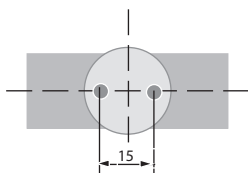

The valve has 2 bore holes M6 on the bottom.

DIMENSIONS

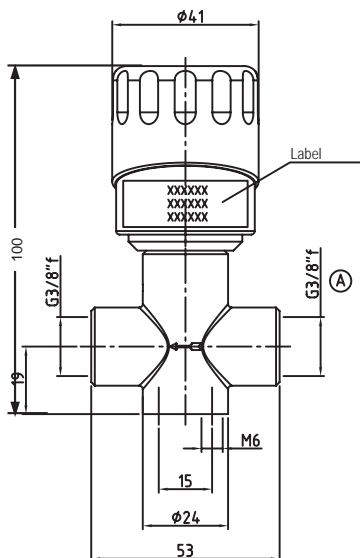

TECHNICAL DATA

Body:	Stainless steel 1.4404 specially cleaned and electro-polished or Brass CW614 (CuZn39Pb3), specially cleaned or Brass CW614 (CuZn39Pb3) chrome-plated
Body seals:	Diaphragm Hastelloy C
Seals:	PCTFE
Leakage rate:	$< 1 \times 10^{-6}$ mbar l/s He (seats), $< 1 \times 10^{-9}$ mbar l/s He (outboard)
Nominal width:	DN 8
Kv-value:	0.5
Dimensions (w×h×d):	approx. 53×100×42 mm
Working temperature:	-25° to 70°C / -13 °F to 158 °F
Weight:	approx. 380 g
Turns:	approx. 1.5
Inlet filter:	100 µm mesh
Vacuum capable:	yes
Inlet/Outlet:	NPT 1/4" f or G3/8" f

ORDER CODE

Type	Material	Upstream pressure	Inlet	Outlet	Gas type
MVR 501 G	BC	40	G38F	G38F	GAS
MVR 501 G	B = brass - G3/8" f BC = brass chrome-plated - NPT 1/4" SS = stainless steel - NPT 1/4" f SS = stainless steel - G3/8" f	40 bar / 600 psi	G38F = G3/8" f N14F = NPT 1/4" N14F = NPT 1/4" G38F = G3/8" f *	G38F = G3/8" f N14F = NPT 1/4" N14F = NPT 1/4" G38F = G3/8" f *	Please specify

PACKED REGULATING VALVES FAV 115 V/T

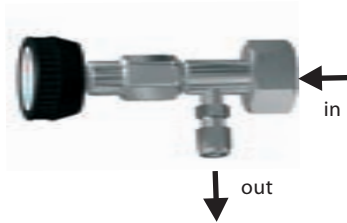

FAV 115 V - with tube fitting 6 mm

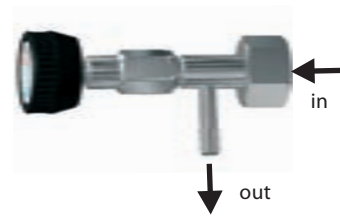

FAV 115 V - with tube fitting 8 mm

**Valve with cylinder connection,
for corrosive gases/gas mixtures, without oxygen/synthetic air,**
inlet pressure: **FAV 115V: 230 bar / 2900 psi**
FAV 115T: 10 bar / 145 psi

SPECIAL FEATURES

- Housing and cylinder connection made out of electro-polished stainless steel
- Regulating cone made out of hard metal
- Stuffing box material woven PTFE
- Angle formed, nominal width DN 2

DESCRIPTION

These packed valves are mounted directly on the cylinder valve.

APPLICATION

For the extraction and adjustment of corrosive gases from pressurised gas cylinders. The cylinder valve serves, for example, the constant adjustment of gases in pressureless polymerisations process.

INFORMATION

The secure handling of highly toxic gases absolutely requires the use of valves with metal bellows or a metal diaphragm. Where constant outlet pressure and precise flow control are necessary, then chose one of the pressure regulators from the GCEDruVa program.

MOUNTING

The use of hose clips is highly recommended when using hoses. To avoid diffusion of nitrogen or helium through the hoses please consider the installation of metal tubes or take make the necessary security precautions.

TECHNICAL DATA

Body:	Stainless steel 1.4404 specially cleaned and electro-polished
Working temperature:	max. -20° to 50 °C / 122 °F
	-25° to 70°C / -4 °F to 158 °F
Leakage rate:	1×10 ⁻³ mbar l/s Helium, seats and outboard
Inlet Filter:	100 µm mesh
Body seals:	PTFE
Nominal width:	DN2
Outlet:	FAV 115 V: tube fitting 6 mm
	FAV 115 T: hose fitting 8 mm (to max. 10 bar)
Cylinder connection sizes :	see chapter 5

ORDER CODE

Type	Material	Upstream pressure	Inlet	Outlet	Gas type
FAV 115V	SS	F	DIN	CL6	GAS
FAV 115 V	SS = stainless steel	F = 230 bar /3300 psi for FAV 115 V	DIN	CL6*	Please specify (no oxygen)
FAV 115 T		10 = 10 bar for FAV 115 T	ANSI AFNOR NBN BS 341 CGA NEN UNI	NO8 = with hose connection 8 mm others on request	

CYLINDER CONNECTION VALVES FAV 500-36/-37

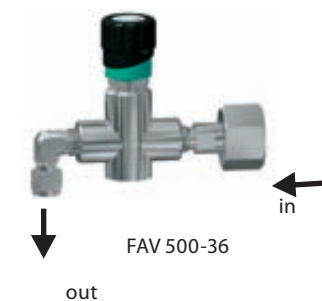

Valve with cylinder connection, for inert, reactive, flammable and oxidizing gases and gas mixtures, no oxygen, purity max. 6.0, inlet pressure 50 bar / 725 psi

SPECIAL FEATURES

- Cylinder connection valve in diaphragm format
- Precise regulation of gas flow
- Hardened stainless steel cone for longer life span
- Optimum purge conditions through minimised dead space

DESCRIPTION

A new generation of diaphragm valves was developed with the series MVR-A 500, which are characterized through its outstanding functional safety and high leak-tightness. This layout as cylinder valve FAV 500 is available with or without a gauge.

APPLICATION

As cylinder valve for gas cylinders with a low cylinder pressure, less than 50 bar, for the adjustment of the gas flow.

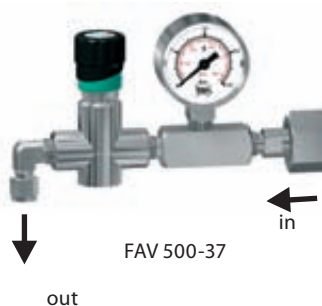

TECHNICAL DATA

Body:	Stainless steel 1.4404 specially cleaned and electro-polished or brass CW614 (CuZn39Pb3) specially cleaned, nickel-plated and chrome-plated
Body seals:	hardened metal (Stainless steel), SS-cone hardened (Brass)
Diaphragm:	Hastelloy, Elgiloy
Leakage rate:	< 1×10 ⁻⁶ mbar l/s He (seats) < 1×10 ⁻⁹ mbar l/s He (outboard)
Nominal width:	DN2
Kv-value:	< 0.02
Vacuum capable:	yes
Filter:	100 µm on inlet and outlet
Weight:	approx. 500 g (Type -36), 800 g (Type -37)
Dimensions (wxhxd):	approx. 120×90×40 mm (Type -36) approx. 180×100×40 mm (Type -37)
Operation:	approx. 10 turns
Outlet:	Tube fitting 6 mm
Cylinder connection sizes :	see chapter 5

ORDER CODE

Type	Material	Upstream pressure	Inlet	Outlet	Gas type
FAV 500-36	BC	E	DIN	CL6 BC	GAS
FAV 500-36	BC = brass	E = 50 bar/720 psi	DIN	CL6 (standard)	Please
FAV 500-37	chrome-plated		ANSI	CL8*	specify
	SS = stainless		AFNOR	CL10	(no O2)
	steel		NBN	CL12	
			BS 341	BC = brass	
			CGA	chrome-plated	
			NEN	SS = stainless steel	
			UNI		

LASER PROCESS GAS SUPPLY

CYLINDER PRESSURE REGULATOR FMD 100/130-14

For the laser gas supply with gas cylinders
Single-stage, with automatic switch over, for cylinder and bundle supply.

Inlet pressure 230/315 bar
Outlet pressure: 0 - 40 bar
Outlet: NPT 1/4" f



POINT-OF-USE REGULATOR EMD 100-06

For the decompression of laser gases at the point-of-use.
Single-stage, brass, mounted on an aluminium plate.

Inlet pressure 40 bar, 600 psi (O₂), 20 bar, 290 psi (N₂).
Downstream pressure 30 bar / 430 psi (O₂), 16 bar / 235 psi (N₂)
Inlet: Ball valve G 1/2" female
Outlet: G 3/8" female



GAS SUPPLY PANEL TDS

For high pressure tank supply.

Single-stage

Inlet pressure: 33 bar

Downstream pressure: 18 bar (O₂), 29 bar (N₂)

Inlet/ Outlet: Ball valve 1" f



GAS PANEL FOR UNINTERRUPTED GAS SUPPLY WITH SEMI-AUTOMATIC SWITCH OVER, FOR BUNDLE



GAS PANEL FOR 2 CYLINDERS BMD 100-39

Single-stage, with automatic switch over, for cylinder and bundle supply. Inlet pressure 315 bar (4500 psi).

Inlet: Stainless steel pigtail connection or flexible convoluted hose

Outlet: Ball valve G 1/2" f

PLEASE NOTE:

The use of contact gauges and a signal box recommended with gas panels with semi-automatic switch over, to ensure an uninterrupted gas supply

CYLINDER PRESSURE REGULATORS FMD 100/130-14



Single-stage, for technical gases and laser gases,
inlet pressure 230 bar / 3300 psi (FMD 100-14) or
 315 bar / 4500 psi (FMD 130-14),
downstream pressure range 0 - 40 bar / 0 - 600 psi

SPECIAL FEATURES

- For laser process gases
- For high flow rates
- Safety gauge pursuant to EN 562
- Relief valve on outlet

DESCRIPTION

The pressure reduction takes place here in a single-stage pressure regulator with inlet and outlet gauges. The relief valve protects from over pressure.

APPLICATION

The cylinder pressure regulators are the simplest and reasonably priced solution in cases where gas supply of the laser-material processing can be interrupted. Among other applications, this pressure regulator can be used for the initial operation of laser installations.

TECHNICAL DATA

Body:	Brass 2.0402 (CuZn40Pb2)
Housing:	Zinc alloy Zn Al3
Body seals:	NBR 70° IRH
Seat seals:	PA 6.6 Zytel 103 Dupont
Piston seals (for N ₂):	Silicon rubber 80° IRH
Diaphragm (for O ₂):	EPDM
Working temperature:	-40 °C to 50 °C, -40 °F to 148 °F
Dimensions (wxhxd):	approx. 190×110×130 mm
Weight:	approx. 1.4 kg
Performance data:	see chapter 5
Pressure gauge range:	0 - 400 bar / 5800 psi, 0 - 515 bar / 7450 psi 0 - 65 bar / 950 psi
Downstream pressure:	0 - 40 bar/580 psi (N ₂) 0 - 16 bar/230 psi (O ₂)
Cylinder connection sizes :	see chapter 5
Inlet:	manual cylinder connection DIN 477-5 for 300 bar/4500 psi or pursuant to DIN 477-1 for 200 bar /2900 psi
Outlet:	NPT 1/4"f, optional tube fitting

ORDER CODE

Type	Material	Upstream pressure	Downstream pressure	Inlet	Outlet	Gas type
FMD 100-14	B	F	40	DIN	CL12	N₂
FMD 100-14	B = brass	F = 230 bar/3300 psi (FMD 100-14)	40 = 0 - 40 bar/ 600 psi (N ₂)	DIN	0 =	Nitrogen
FMD 130-14		G = 315 bar/4500 psi (FMD 130-14)	16 = 0 - 16 bar/ 230 psi (O ₂)	ANSI AFNOR NBN BS 341 CGA NEN UNI	NPT1/4"f CL10 CL12*	Argon Oxygen

GAS PANELS TDS



**Single-stage,
for high pressure tank supply,
inlet pressure 33 bar / 480 psi,
downstream pressure O₂: 18 bar / 260 psi, N₂: 29 bar / 420 psi**

SPECIAL FEATURES

- For laser process gases
- For high flow rates
- For minor pressure differentials between upstream and downstream pressure level

DESCRIPTION

This gas panel, with control regulator and main pressure regulator, is protected by a zinc coated steel housing. It is particularly suitable for tank gas supply with a high flow rate and downstream pressures of max. 18 bar for oxygen and 29 bar for nitrogen and indicated by the downstream pressure gauge. Improper pressure levels are controlled by a relief valve, actuating at 19/32 bar. The desired flow rate is set by way of the ball valves at the outlet and inlet.

APPLICATION

These stations deliver extreme high flow rates with constant pressure level for oxygen and nitrogen process gas and tank gas supply.

TECHNICAL DATA

Body:	Brass 2.0402 (CuZn40Pb2)
Seat seals:	EPDM
Ball valve seals:	PTFE
Working temperature:	-20 °C to 100 °C / -4 to 210 °F
Dimensions (w×h×d):	approx. 750×500×322.5 mm
Gauges:	RM 63-40
Flow rate:	>150 Nm ³ /h N ₂ / 88 SCFM
Performance data:	see chapter 5
Pressure level:	19 bar for O ₂ / 275 psi 32 bar for N ₂ / 465 psi
Downstream pressure:	18 bar O ₂ / 260 psi 29 bar N ₂ / 420 psi
Inlet/Outlet:	Ball valve 1" f, Option 2" female

DIMENSIONS

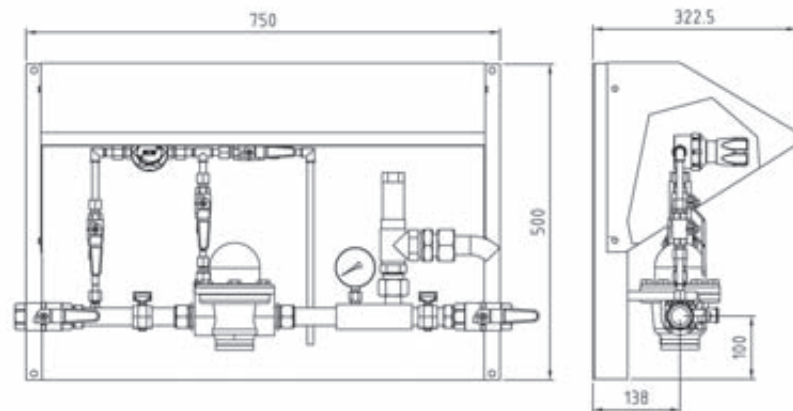

ORDER CODE

Type
TDS 18
TDS 18
TDS 29

Gas type
GAS
Oxygen
Nitrogen

GAS PANELS BMD 100-39

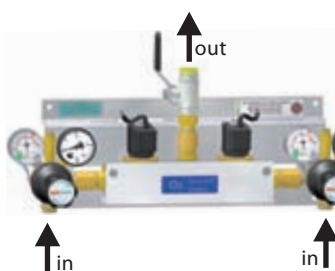

**Single-stage,
for cylinder or bundle supply,
for technical gases and laser gases,
inlet pressure 315 bar / 4500 psi,
downstream pressure 0 - 40 bar/ 600 psi (N₂) or 0 - 16 bar/ 230 psi (O₂)**

SPECIAL FEATURES

- For the supply with laser process gases
- Uninterrupted gas supply with automatic switch over
- The solenoid valve guarantees maximum flow rate
- Acoustic and optical gas supply monitoring with contact gauges

DESCRIPTION

The BMD 100-39 consists of two single-stage pressure regulators with inlet gauges, the downstream pressure on this pressure regulator can be individually adjusted left and right and monitored on the outlet gauge. The solenoid valve block and control unit allows for the switch over through settings on the contact gauges to optional pressure levels. A 3/2 way direct acting solenoid valve for high purity gases prevents the back flow of gases into the empty cylinder.

APPLICATION

This gas panel is used for process gases such as nitrogen as well as rare gases (Argon) from cylinder or cylinder packs for laser material processing. It is also used when an uninterrupted process gas supply with fully automatic switch over is required.

TECHNICAL DATA PRESSURE REGULATOR

Body:	Brass 2.0402 (CuZn40Pb2)
Housing:	Zinc alloy Zn Al3
Body seals:	NBR 70° IRH
Seat seals (for N ₂):	PA 6.6 Zytel 103 Dupont
Seat seals (for O ₂):	PA 6.6 Zytel 103 Dupont
Piston sealing (for N ₂):	Silicon rubber 80° IRH
Diaphragm (for O ₂):	Neoprene
Ball valve seals:	PTFE, chambered
Working temperature:	-20 °C to 50 °C, -4 °F - 148 °F
Performance data:	see chapter 5
Dimensions (w×h×d):	approx. 400×180×170 mm
Weight:	approx. 5.9 kg
Pressure gauge range:	0 - 400 bar, 0 - 65 bar, 0 - 6000 psi, 0 - 850 psi
Flow rate:	performance data see chapter 5
Inlet:	W21.8×1/14"
Outlet:	Ball valve G 1/2"female

TECHNICAL DATA CONTROL UNIT

Power supply:	230 V, 50 Hz
Working temperature:	0 to 55 °C
Dimensions (l×w×h):	approx. 200×120×95 mm
Weight:	approx. 1.2 kg
Signal lamps:	yellow: active gas cylinder, red: gas supply run out, green: power supply OK
Input keys:	Manual selection gas cylinder A, Manual selection gas cylinder B, Acknowledge fault/ alarm

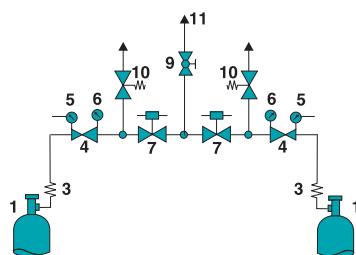

- 1 Cylinder connection
- 3 Flexible convoluted hose
- 4 Pressure regulator
- 5 Inlet gauge (KI)
- 6 Outlet gauge
- 7 Solenoid valve
- 9 Outlet ball shut-off valve
- 10 Relief valve
- 11 Process gas outlet

ORDER CODE

Type	Material	Downstream pressure	Outlet	Gas type
BMD 100-39	B	G	V22	N2
	B = brass	E = 0 - 40 bar / 600 psi (N ₂) D = 0 - 16 bar / 235 psi (O ₂)	0 = without CL22*	Nitrogen Oxygen Argon

CALIBRATION GAS MEASURING

EXCERPT OUT OF REFERENCES FOR GCEDRUVa EQUIPMENT

AUDI
BOSCH
DAIMLER CHRYSLER
FORD
German Automobile Club
HONDA
HORIBA
IAV
MAGNETI MARELLI
NISSAN
OPEL
SUZUKI
VDO
VOLKSWAGEN

Belgium
China
Germany
Hungary
South Africa
Turkey



Point-of-use cabinet

APPLICATION AREAS

Research and development of combustion engines
 Development and production of Catalysts
 Development of injection systems
 Control units for fundamental research
 Support for Combustion research
 Ignition system development
 Exhaust gas measuring

SCOPE OF DELIVERY

Planning
 Point-of-use cabinet
 Central gas supply
 Tubing systems

GCEDRUVa'S CUSTOMER SERVICE

Right from the start GCEDruVa supports planning engineers, operators and users, manufacturers, general enterprises and architects offices beginning with the planning phase.

On the basis of many years of experience GCEDruVa gives support for selection and organization of first and second stage pressure gas supply, for tubing and tube layout, cylinder stock rooms and monitoring devices.

Central gas supply

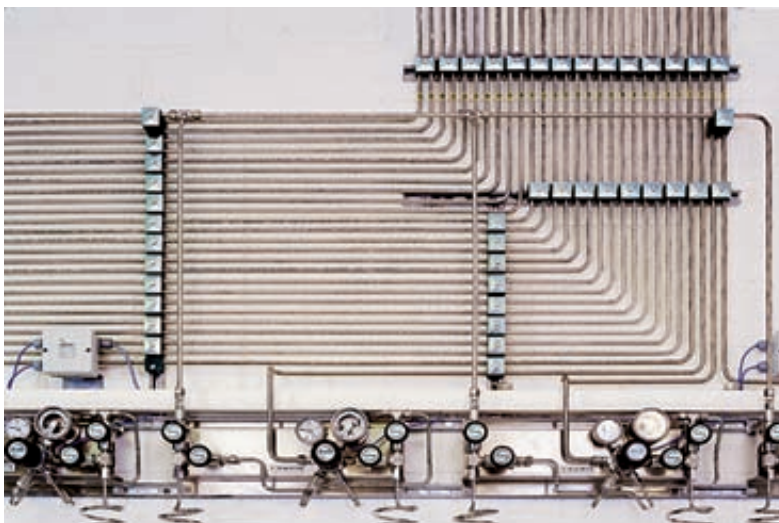

Point-of-use cabinet with integrated low gas signalling



POINT-OF-USE REGULATORS EMD 400/3000

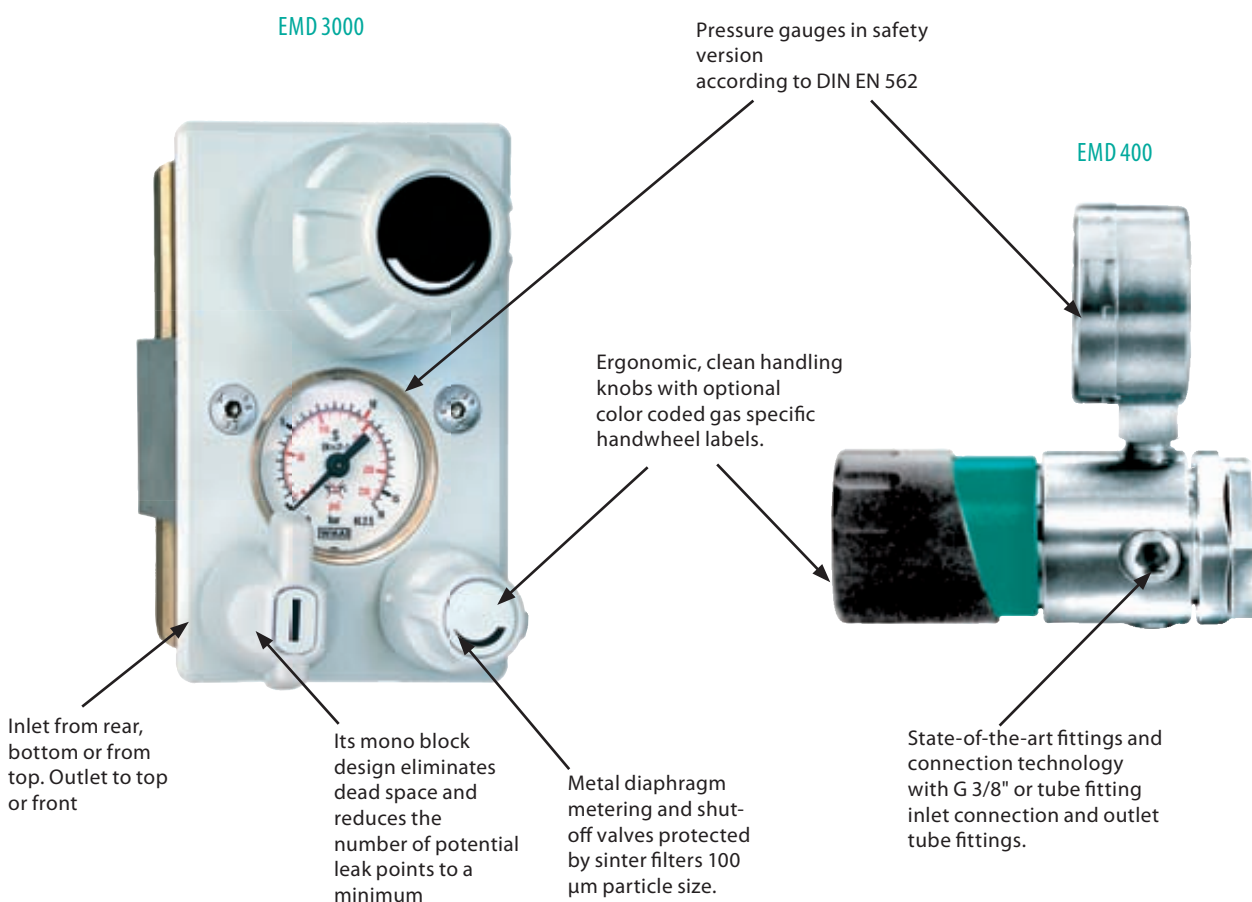

Single stage regulators at high performance.
Inlet pressure 40 bar.
Outlet pressure range 0,1 - 10,5 bar / 7 - 150 psi,
analytical version 0,1 - 2,2 bar / 1,5 - 33 psi.

Available in different versions and combined with angle and straight version regulating and shut-off valves, this results in a unique adaption and makes these modules suitable for the most common laboratory applications and for lab furnitures of all manufacturers: suspended versions, bench mounting, surface and inset wall assembly or mounted on plates.

BASIC DESIGN ASPECTS*

MATERIAL

stainless steel 316L (1.4404) specially cleaned and electro-polished or brass 2.0401.26.

SEALING MATERIAL

Seats: FKM and FFKM with stainless steel, FKM and EPDM with brass.
 Seals: PCTFE with stainless steel and PVDF with brass. This depends on gas specification and purity requirements. Material is specified in "Technical data".

INNER PARTS

Low maintenance, service friendly regulator unit, particle filter 10 µm SS-filament at the inlet.

DIAPHRAGM

Good protection against burst and corrosion due to diaphragm material Hastelloy.

PERFORMANCE DATA

See flow charts, for different pressures please contact GCE.

GUARANTEED LEAKAGE RATE

$< 1 \times 10^{-9}$ mbar l/s Helium.

PURITY

Cleanness and leak tightness according to the demand of high purity ≤ 6.0 applications.

WORKING TEMPERATURE

-20 °C to +70 °C / -4 to 160 °F.

INLET / OUTLET CONNECTIONS

Inlet G 3/8", others with adapters. Outlet tube fitting for 6 mm tube, others on demand.

*Different data to series specification are listed in the product specific "Technical Data".

POINT-OF-USE REGULATORS EMD 3000



built in version



wall mounted



suspended version



bench mounted

For inert, flammable and corrosive gases and gas mixtures, purity max. 6.0, inlet pressure 40 bar / 600 psi, analysis version 10 bar / 145 psi, outlet pressure range 0,1 - 10,5 bar / 1 - 150 psi

HIGHLIGHTS

- Laboratory demand conform system design achieved by optimizing the component relating properties
- ECD-suitable
- Analysis version available (EMD 3004)

FEATURES

Due to its modular design with/without shut-off or regulating valve and manifold inlet/outlet configurations, the EMD 3000 can be delivered in various configurations. Even surface colour may be adapted to customer's demand. Metal diaphragm design, click valves and a gas consistent sealing system make it an ideal choice for all HP laboratory gases including ECD applications. The mono block design eliminates any dead space and reduces the number of connections/fittings to just the inlet and outlet port. Inlet might be configured from top or rear, outlet from top to bottom, top or front (via metering valve with outlet nozzle).

APPLICATION

Designed as a Point-of-use pressure regulator the single-stage EMD 3000 series eliminates the frequent supply pressure changes in central gas supply systems caused by pressure drop. It provides a constant delivery pressure for instruments and analyzers.

With its unique adaption system the EMD 3000 make it suitable for the most common laboratory applications and for lab furnitures of all manufactures. The bench mounting design allows easy installation on benches and worktables. Wall mounting allows easy assembly to walls and front panels. Combined with adapters it may also be mounted suspended on supply channels or ceilings. All operative elements are in each case ergonomically located at its front.

TECHNICAL DATA

Body:	stainless steel 316L (1.4404) specially cleaned and electro polished or brass 2.0401.26
Diaphragm:	Hastelloy C 276
Gauges:	safety gauge acc. to EN 562, 40 mm, dual scale
Weight:	1,9 kg / 3.5 lbs (w/o turret)
Counter top hole:	13/16" diameter
Panel installation size:	10 × 5,6 × 4 cm / 4 × 2.2 × 1.6" (h × w × d)
Wall installation size:	14 × 6,4 × 4 cm / 5.5 × 2.5 × 1.6" (h × w × d)
Panel thickness:	max. 5 mm - 3/16"
Performance:	see chapter 5

Other inlet/outlet options on request

POSITION

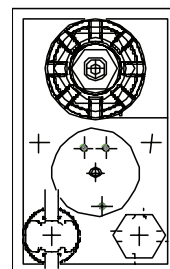

North

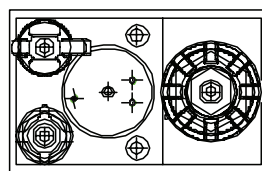

East

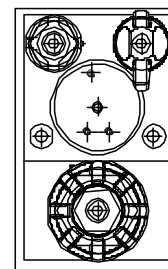

South

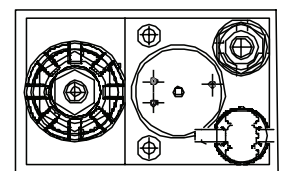

West

ORDER CODE

Type	Version	Valves	Material	Outlet pressure	Position	Inlet conn.	Outlet conn.	Gas type
EMD 3000	W	10	B	4	N	0 BC	CL6 BC	GAS
EMD 3000 = standard	B = built-in version W = wall mounted	10 = complete 08 = without shut-off valve	B = brass SS = stainless steel	EMD 3000: 1 = 0,1 to 1 / 1 - 15 psi 4 = 0,2 to 4 / 3 - 60 psi 10 = 0,5 to 10,5 bar / 7 - 150 psi	N = north E = east S = south W = west	0 = without CL6, CL8 CL1/8, CL3/8 BC = brass SS = stainless steel	0 = without CL4, CL6, CL8 CL 1/4, CL 1/8" NO 1/4" NO 1/8" BC = brass SS = stainless steel	please specify
EMD 3004 = analysis version	S = suspended version T = bench mounted	06 = without regulating valve 04 = only valve block		EMD 3004: 2,2 = 0,1 - 2,2 bar / 1,5 - 32 psi 4 = 0,5 - 4 bar / 7 - 60 psi				

Outlet expl.: CL6 = tube fitting 6 mm, others on demand

POINT-OF-USE REGULATOR LAB 400



EMD 400-01



MVA 400 W



MVA 400 G



MVR 400 W



MVR 400 G

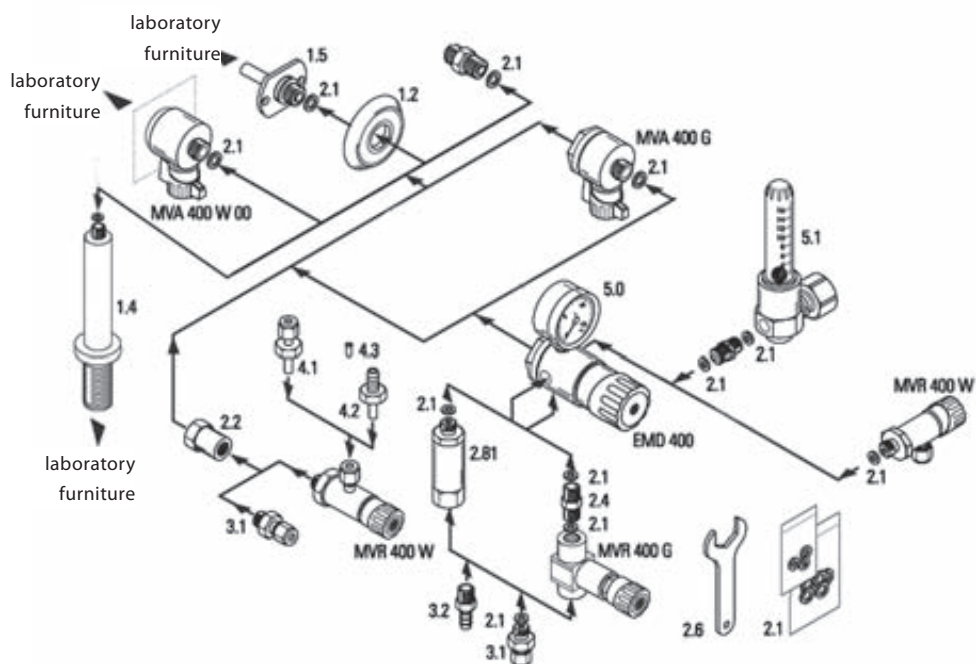

NO.	TYPE	FUNCTION	MATERIAL	ART.-NO.
1.2	Closing cap	Cap to cover the wall connector (1.5).		H19006625
1.3	Adapter fitting G 3/8" m > G 3/8"m	Threaded adapter fitting to connect shut-off valve resp. pressure regulator and other female threaded outlets G 3/8"	stainless steel	H23303701
1.4	Upright pipe conn. G 1/4" f > G 1/4"m	Connector for table mounting		H28590603
1.5	Wall connector 8 mm > G 3/8"m	Mounting LabSystem components at laboratory furniture walls	brass	H23303403
1.51	Wall connector NPT1/4" f > G 3/8"m	Mounting LabSystem components to laboratory furniture walls	brass stainless steel	H23303203 H23303201
2.1	Sealing 14,0 × 9,0 × 2,0 mm (G 3/8") 11,2 × 5,5 × 1,5 mm (G 1/4") 14,0 × 9,0 × 2,0 mm (G 3/8") 11,2 × 5,5 × 1,2 mm (G 1/4") 11,2 × 5,5 × 1,5 mm (G 1/4") 11,2 × 5,5 × 2,1 mm (G 1/4")	for brass version for stainless steel version	PVDF PVDF PCTFE PCTFE PCTFE PCTFE	H09010316 H09008919 H09010309 H09011809 H09008909 H09009009
2.2	Adapter fitting G 3/8" f > G 1/4" f	Reducing adapter to connect the control valve with the wall connector (1.1)	brass	H23302253

NO.	TYPE	FUNCTION	MATERIAL	ART.-NO.
2.4	Male connector G 1/4"m > G 1/4"m	To connect the control valve MVR 400 G or the flow meter SVM 400 with the pressure regulator EMD 400	brass stainless steel	A000105 A000104
2.6	Spanner, wrench size 36	Special LabSystem Spanner for EMD 400, ZB 400, MVE 400E and MVE 400G.	steel plated	H11006405
2.81	Flame arrestor FS 400 G 1/4"m > G 1/4" f	For the use of acetylene	stainless steel	L000110
3.1	Tube fitting for EMD 400 G 1/4" > tube	Outlet screwed connection for EMD 400.	brass 1/8" brass 6 mm brass 10 mm stainless steel 1/8" stainless steel 6 mm stainless steel 10 mm	A000121 A000123 A000125 A000120 A000122 A000124
3.2	Hose nozzle fitting for EMD 400 G 1/4" > hose nozzle	Outlet screwed connection for EMD 400, outer diameters of hose nozzles = inner diameters of hose.	brass 4 mm brass 6 mm brass 8 mm	H03825573 H03825673 H03825773
4.2	Hose nozzle fitting for SVR 400 W G 1/4" > hose nozzle	Outer diameters of hose nozzles = inner diameters of hose.	brass 4 mm brass 6 mm brass 8 mm stainless steel 4 mm stainless steel 6 mm	H03825203 H03825303 H03825403 H03825201 H03825301
4.3	Supporting tube 6 x 4 mm		stainless steel	H03804401
5.0	Pressure gauge RM 50 inlet: G 1/4"m	Enables the use of PE- resp. PTFE-hoses in tube fittings Spring-tube gauge, rating diameter 50 mm, metallic housing, precision class 2.5.	stainless steel brass	see accessory
5.1	Flow meter SVM 400, without adapter G 1/4" f > G 1/4" f	Flow indication with fine adjustment valve 0 - 60 l/h air 0 - 120 l/h air 0 - 960 l/h air 0 - 1500 l/h air		on demand

Legend:

f = female thread, **m** = male thread

G 1/4" f > G 1/4" m means: **inlet** G 1/4" female thread and **outlet** G 1/4" male thread.

AVAILABLE ACCESSORY

Large range of mounting and assembling accessory (see Accessory), especially tube fittings and hose adaptors.

POINT-OF-USE REGULATORS EMD 400/404



EMD 400-01

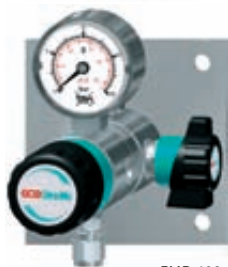

EMD 400-06
wall mounted,
inlet from top



EMD 400-42
plate assembly,
inlet from rear



EMD 400-41
Bench version

**Single-stage,
for inert, reactive, flammable and oxidizing gases and gas mixtures,
purity max. 6.0,
inlet pressure 40 bar / 600 psi,
outlet pressure range 0,1 - 10,5 bar / 1 - 150 psi**

HIGHLIGHTS

- ECD-suitable
- Great variety of assembly possibilities in laboratory furniture due to the modular design of the LabSystem
- Gas type specific colour indication labels according to DIN 13792
- Analysis version available

FEATURES

Standard version regulator with gauge, inlet at rear, outlet downwards. May be combined with inlet shut-off valve MVA 400, wall connector, metering valve MVR 400G and MVR 400W, different gauges and diverse accessory (see previous pages).

APPLICATION

For wall, plate, suspended and bench mounting, with great variety of combinations, covering any laboratory gas supply demand.

TECHNICAL DATA

Body material:	stainless steel 316L (1.4404) specially cleaned and electro polished or brass CW614 (CuZn39Pb3) specially cleaned, chrome-plated
Performance:	see chapter 5
Pressure gauge range:	0 - 2,5/6/16 bar (0 - 35/85/ 235 psi) type 404: 0 - 3 / 6 bar (0 - 45/85 psi)
Weight:	0,8 kg
Inlet - outlet:	G 3/8" f - G 1/4" f

ORDER CODE

Type	Variation	Material	Outlet pressure	Outlet conn.	Gas type
EMD 400	-01	BC	1	CL6 BC	GAS
EMD 400 = standard EMD 404 = analysis version	-01 = standard -06 = plate mounted -41 = bench version -42 = wall assembly	BC = brass chrome- plated SS = stainless steel	EMD 400: 1 = 0,1 to 1 bar / 1 - 15 psi 4 = 0,2 to 4 bar / 3 - 60 psi 10 = 0,5 to 10,5 bar / 7 - 150 psi EMD 404: 2,2 = 0,1 - 2,2 bar / 1,5 - 32 psi 4 = 0,5 - 4 bar / 7 - 60 psi	0 = without CL4, CL6, CL8 CL 1/4, CL 1/8" NO 1/4" NO 1/8" BC = brass SS = stainless steel	please specify

LABORATORY PRESSURE REGULATOR EMD 3100

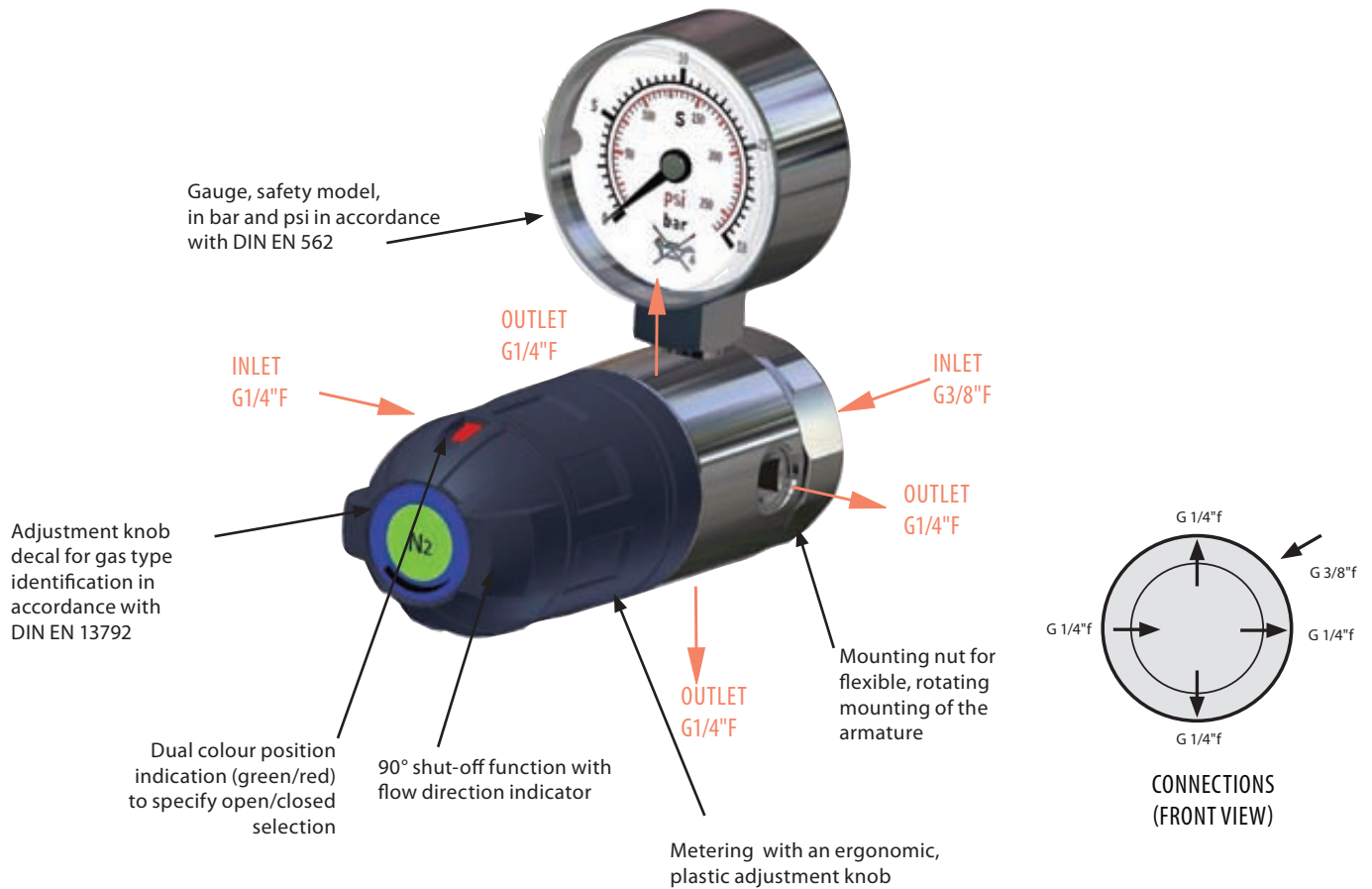

PRESSURE REGULATOR WITH SHUT-OFF FUNCTION

This highly compact version of a pressure regulator combines, in a very small space, pressure regulation and shut-off function of gas flow. This is achieved through a successful combination of the pressure regulator parts with few extra shut-off components. Thereby reducing the pressure regulator and shut-off valve, normally as separate components, to a minimum. The structural size achieves the minimum dimensions. With this construction the inlet and outlet can be attached and interchanged with the greatest flexibility. The use of perfected, core components of the Series 400, available since decades, together with a few new elements ensures the performance and high quality of this construction from the beginning.

SERIES SPECIFIC DATA*

VERSION

Single-stage pressure regulator with high performance values (see chapter 5).

Inlet pressure 40 bar.

Downstream pressure range 0.2 - 10.5 bar / 7 - 150 psi,

Analysis version (EMD 3104) 0.1 - 2.2 bar / 1.5 - 33 psi.

MATERIAL

Stainless steel 316L (1.4404) specially cleaned and electro-polished or brass 2.0401.26 nickel-plated and chrome-plated.

SEAL MATERIAL

Seat: FKM and FFKM with stainless steel, FKM and EPDM with brass.

Seals: PCTFE with stainless steel and PVDF with brass in dependent upon gas used. Material is specified in each case in the "Technical Data".

INNER PARTS

Low-maintenance, easy to service, pressure regulating unit, with particle-filter in stainless steel and 50 µm mesh at inlet G3/8" f eg. 100µm at inlet G1/4" f.

MODULAR SYSTEM FOR MAXIMUM FLEXIBILITY OF CONFIGURATION AND SCOPE OF APPLICATION

The basic version is available in the form of flush or surface wall mounting, bench mounted or hanging version. The use of system components from the similar series 400 further allowing for countless variations in the combination possibilities with the configurations of inlets and outlets, which can be tailored to the customers wishes: with regulating valve in elbow and straight versions (DN5), with additional inlet shut-off valve (in elbow or straight form), with flow meter or with diverse wall adaptors.

In this modular form this point-of-use system is particularly compatible and suitable for all lab applications and lab furnishings.

DIAPHRAGM

Increased safety against burst and corrosion defects with the Hastelloy diaphragm.

GUARANTEED LEAKAGE RATES

< 1×10⁻⁹ mbar l/s Helium (outboard),

< 1×10⁻⁶ mbar l/s Helium (seat)

PURITY

Purity and leakage rates comply with the requirements for applications with high gas purity ≤ 6.0.

WORKING TEMPERATURE

-25 °C to +70 °C / -13 to 160 °F.

INLET / OUTLET CONNECTIONS

Inlet G 3/8" f, adaptors for other connections. Outlet connection for 6 mm tube, others upon request.

*Differing data of the individual products in this section are listed in each case under "Technical Data".

LABORATORY PRESSURE REGULATORS EMD 3100

**Single-stage,
for inert, reactive, flammable and oxidizing gases
and gas mixtures,
purity max. 6.0,
EMD 3100: Inlet pressure 40 bar, downstream pressure 0.1-10 bar
EMD 3104 (analysis version): Inlet pressure 12 bar,
Downstream pressure 0.1-4.4 bar**

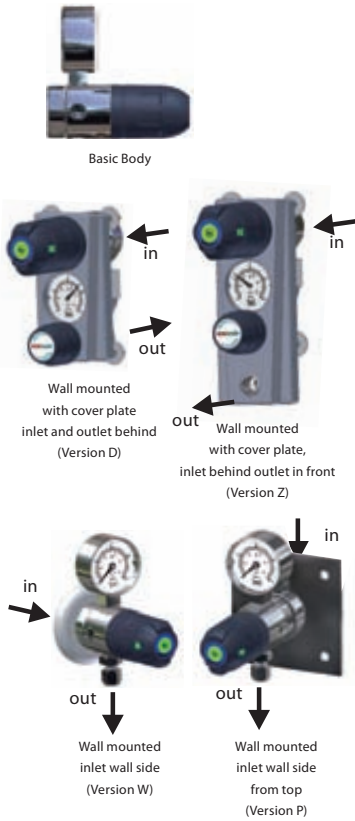

SPECIAL FEATURES

- Pressure regulator with integrated shut-off function
- Coloured identification of shut-off positions
- Highly compact form
- ECD-compliant
- Ergonomic positioning of the operational elements
- User-friendly system solutions for laboratory applications through optimum arrangement of components with one another
- Gas type specific adjustment knob identification according to DIN EN 13792
- Analysis version optionally available

DESCRIPTION

The basic version of this pressure regulator with gauge includes an integrated quick-closing function. The gas type is indicated on the front side of the pressure regulator with the appropriate decal. The flush mounted version is mounted complete with cover, regulating valve with shut-off function and gauge, whereby the gauge, can be rotated 90° each way depending on the mounting orientation for reading. The wall mounting is achieved using a wall adapter and wall mounting plate, the gas supply is brought in through the wall. Further installation versions (on mounting plates) allow for the gas supply to come from the top or the bottom. The bench mounting or the wallmounted version is simply and flexibly accomplished with the help of the same adaptor (delivered accordingly mounted). Numerous other variations are possible, see separate data sheet.

APPLICATION

This highly compact, space saving designed laboratory point-of-use regulator is suitable for flush or surface wall mounting, for installation on tables or a wallmounted version as well as the installation in diverse supply channels. This systems versatile configuration options cover all the customary lab applications and fits to all laboratory furnishings. An analysis version (LAB 3104) is specially designed for low pressure applications and offers extremely fine adjustment possibilities for pressure and flow rate.

DIMENSIONS

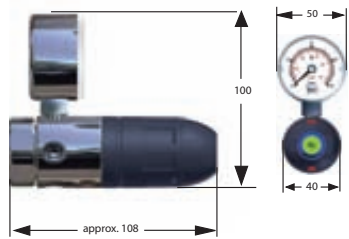

TECHNICAL DATA

Body:	Stainless steel 316L (1.4404) specially cleaned and electro-polished or brass
	CW614 (CuZn39Pb3) specially cleaned, nickel-plated and chrome-plated
Gauge:	safety gauge according to EN 562
	Nominal width 50 mm, class of accuracy 2.5
Pressure gauge range:	0 - 2.5 / 6 / 16 bar, 0 - 3 / 6 bar (Type 3104)
Dimensions (wxhxd):	approx. 50x100x108 mm
Weight:	approx. 0.64 kg (Basic body)
Inlet - Outlet:	G 3/8" f or G 1/4" f or NPT1/4" f —G 1/4" (depending on version)

ORDER CODE

Type	Periphery	Material	Upstream pressure	Downstream pressure	Version**	Pressure gauge adjustment knob orientation	Inlet	Outlet	Gas type
EMD 3100	-01	BC	E	6	0	N	CL8	CL10SS	GAS
EMD 3100 = Standard	-01 = Pressure regulator (MD)	BC = brass	E = 40 bar D = 12 bar	1.5 = 0.2-1.5 bar 6 = 0.5-6 bar	0 = Basic module P = Mounting plate W = with backing plate adaptor T = Bench mount H = Hanging version	N = upwards E = right S = down W = left (For the flush mounted version)	0 = without *	0 = without *	Please specify
EMD 3104 = Analysis version	-06 = MD + HP-shut-off valve -07 = MD + LP-flame arrester -08 = MD + LP-MVAR -10 = MD + HP-shut-off valve + LP-MVAR	SS = stainless steel	A = 1.5 bar (only C2H2)	10 = 0.5-10.5 bar	D = inlet and outlet from behind Z = Inlet from behind, outlet front		CL8** CL10	CL8** CL10	

LABORATORY PRESS REGULATORS EMD 3100 - VARIATIONS

COMBINABLE WITH EMD 3100 SHUT-OFF VALVES AND REGULATING VALVES WITH SHUT-OFF FUNCTION



EMD 3100 COMBINATION POSSIBILITIES

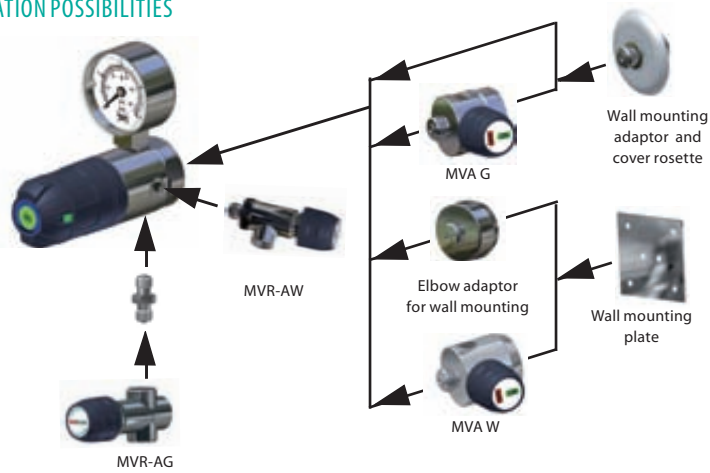

EMD 3100 AS BENCH MOUNT (VERSION T)

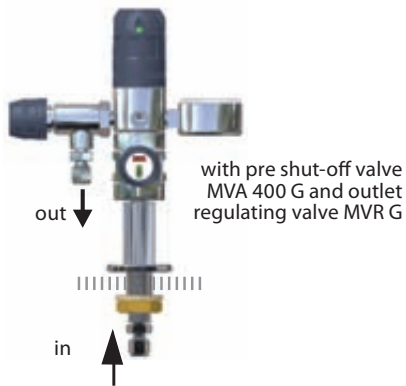

EMD 3100 AS HANGING VERSION (VERSION H)

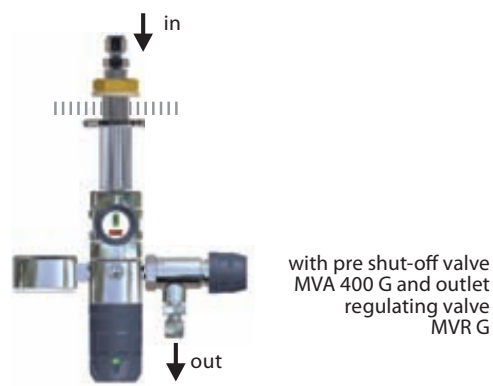

EMD 3100 WALL MOUNTED VERSION (Z) WITH VARIABLE ADJUSTMENT KNOB ORIENTATION

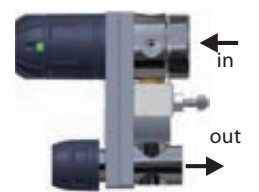

EMD 3100 AS SURFACE MOUNTED (W) WITH WALL ADAPTOR

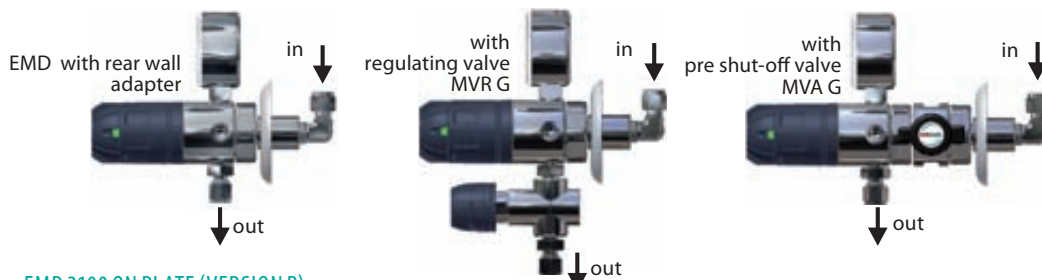

EMD 3100 ON PLATE (VERSION P)

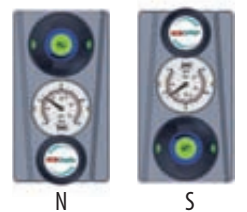
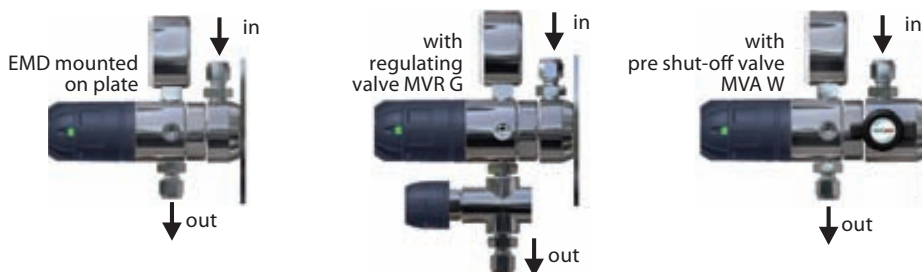

SHUT-OFF VALVES MVA 400 G/W



MVA 400 G

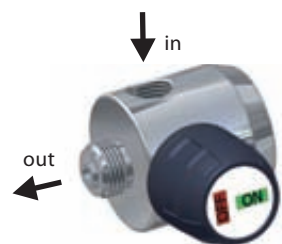

MVA 400 W

MOUNTING

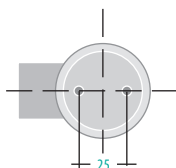

2 bore holes M6 are provided on the MVA 400 W for mounting.

**In-line or elbow form,
for inert, reactive, flammable and oxidizing gases
and gas mixtures,
purity max. 6.0,
inlet pressure 40 bar / 600 psi.**

SPECIAL FEATURES

- Open/close with only quarter turn, clicks into place
- Clearly visible open/closed position
- Wide range of applications due to modular format
- Gas type specific identification according to DIN 13792
- Diaphragm shut-off valve

DESCRIPTION

The MVA 400 G is an in-line version with G3/8". Inlet and outlet The integrated connecting nut allows for screwing the valve on in any position with only one gasket. The MVA 400 W is the elbow version with inlet from the side G1/4" and outlet straight G3/8"m. The MVA 400 W is mounted with 2 M6 mounting screws, 25 mm apart on the backside.

APPLICATION

These valves can be combined in many ways with the components of the lab system (see overview on page 62).

TECHNICAL DATA

Body:	stainless steel 316L (1.4404) specially cleaned and electro-polished or brass
	2.0401.26 pecially cleaned, nickel-plated and chrome-plated
Diaphragm:	Hastelloy
Nominal width:	DN 5
Leakage rate:	< 1×10 ⁻⁹ mbar l/s Helium (outboard),
	< 1×10 ⁻⁶ mbar l/s Helium (seat)

MVA 400 G

Kv-value:	0.2
Seat seals:	PCTFE
Weight:	approx. 600 g
Inlet/Outlet:	G 3/8" f × G 3/8" m

MVA 400 W

Kv-value:	0.25
Seat seals:	PCTFE
Weight:	approx. 500 g
Inlet / Outlet:	G 1/4" f / G 3/8" m

ORDER CODE

Type	Material	Gas type
MVA 400 G	BC	GAS
MVA 400 G	BC = brass	Please
MVA 400 W	chrome-plated	specify
	SS = stainless steel	

SHUT-OFF VALVES MVR 400 G/W



MOUNTING

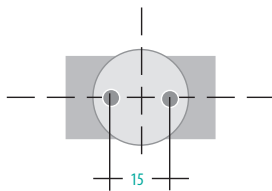

2 bore holes M6 are provided on the MVR-A 400 G for mounting.

For inert, reactive, flammable and oxidizing gases and gas mixtures, purity max. 6.0, inlet pressure 40 bar / 600 psi

SPECIAL FEATURES

- Very fine flow rate adjustment
- Shut-off function
- Gas type specific identification according to DIN 13792
- Diaphragm shut-off valve

APPLICATION

These valves can be combined in many ways with the numerous components of the lab system in particular with the pressure regulator EMD 400.

DESCRIPTION

These regulating valves are characterized by their outstanding operational reliability and extreme leak-tightness. They have very good regulating characteristics and allow for exact delivery for both very small as very large amounts of gas.

TECHNICAL DATA

Body:	Stainless steel 1.4301 specially cleaned and electro-polished or brass 2.0401.26 specially cleaned, nickel-plated and chrome-plated
Diaphragm:	Hastelloy
Body seals:	hardened stainless steel cone
Seat seals:	PCTFE
Leakage rate:	$< 1 \times 10^{-4}$ mbar l/s Helium (seat) $< 1 \times 10^{-7}$ mbar l/s Helium (outboard)
Vacuum capable:	yes
Fine metering:	the adjustment knob has approx. 10 turns
Nominal width:	DN 2
Kv-value:	< 0.02
Working temperature:	-25 °C to 70 °C / -13 °F to 158 °F
Weight:	approx. 280 g
Inlet - Outlet:	MVR-A 400W: G1/4"m - G1/4"f MVR-A 400G: G1/4"f - G1/4"f

ORDER CODE

Type	Material	Gas type
MVR-A 400 W	BC	GAS
MVR-A 400 W	BC = brass	Please
MVR-A 400 G	chrome-plated	specify
	SS = stainless steel	

SIGNAL BOXES DGM-SK 2 /4 /6 /10



Signal box



Intrinsically safe barriers

Signal box, for optical and acoustic signaling of fault reporting, 2, 4, 6 and 10-channel versions

SPECIAL FEATURES

- Optional Fax-/SMS alarm
- Low supply pressure monitoring with contact gauges
- Collective alarm for control room
- Fast system overview
- Installation outside the Ex-Zone

DESCRIPTION

The gas management signal box DGM-SK is a fault indicating unit and can monitor up to ten electrical circuits for deviation from the norm. An integrated lamp and signal horn allow for testing the correct operation of the instrument. If one or more alarm signals are triggered (e.g. gas failure) an acoustic (buzzing noise) and an optical signal (red LED) are emitted for each channel. The acoustic signal is acknowledged by pressing a button, the optical signal does not switch off until all malfunctions have been remedied. The instrument is equipped with a collective alarm to notify a main central office, a control unit or an external signalling device. Any equipment is possible for use as a signal transmitter as long as it has either a mechanical contact or an inductive-contact in accordance with DIN 19234 NAMUR.

APPLICATION

The DGM-SK is used for all kinds of alarm signalling, predominantly for monitoring gas supply or metered flow in gas applications. Monitoring of gas supply can be done by controlling the upstream or downstream pressure (using contact gauges), the weight of the bottle or through monitoring rupture disks, dependent upon model for as many as 10 cylinders simultaneously. Flow-switches, floaters or mass flow controllers are suitable as signal transmitters for the monitoring of metered flow. In connection with these new IT relay stations individual faults can be passed on by SMS or fax. For every individual alarm you can program an individual text or an SMS and also a separate target number.

TECHNICAL DATA

CONNECTION LOAD

Power supply:	230V AC, 50Hz, 5VA; 110V AC, 60Hz
Fuse:	3,15 mA slow-blow
Note:	defective fuses may only be replaced by the manufacturer

INLETS

Signal transmitter:	zero potential, mechanical contacts, initiators comply with DIN 19234 (NAMUR)
Effective direction:	NC (normally closed)
Connection system:	2 wires
Signal transmitter supply:	10 V max. throughout the instrument, 10 mA max. (short circuit proof)
Max. load/circuit:	330 mH/ 4.0 µF (EEx ib IIC); 1000 mH/ 30.0 µF (EEx ib IIB)
Cable monitoring (optional):	Short circuit I > 6 mA, cable break I < 80 µA
Connection cross section:	2.5 mm ² max.

OUTLET (COLLECTIVE ALARM)

Alarm output:	2* relay output (1 change over contact)
Contact load:	max. 230 V ~, 50 Hz, 100 VA max. 48 V , 1 A

INTERNAL ALARM EQUIPMENT

Signal lamp:	LED green 5 mm
Acoustic alarm:	Piezo buzzer, f = 3.3 kHz
Collective alarm:	via zero potential break contact

AMBIENT CONDITIONS

Ambient temperature:	max. 40 °C
Humidity:	0 - 95 % rel. humidity, not condensing

DESIGN

Housing:	Polystyrene colour similar to RAL 7035 (light grey)
Protection category:	IP 54
Dimensions (w×h×d):	200×160×60 mm
Installation position:	upright
Cable glands:	blue: 1 each of PG 9 and PG 11; grey: 1 each of PG 11 and PG 13.5

AVAILABLE ACCESSORIES

Solenoid valve control and regulator DGM-MV, relay box DGM-IT, contact gauges and operation terminal DGM-AX for gas management system, mass flow controller, cylinder scales, rupture disks, floater, flow switch and cable monitoring.

INSTALLATION

The housing is designed for wall mounting outside of a ex-area. Four mounting holes are provided in the back of the housing for this purpose. These can be accessed by unscrewing the cover.

ORDER CODE

Type	Power supply	Ex-protection
DGM-SK 02	220	0
DGM-SK 04	220 = 230V 50 Hz	0 = without
DGM-SK 06	110 = 110V 60Hz	EX = with
DGM-SK 10		

Signal box, for optical and acoustic signaling of fault reporting, 2 or 4-channel versions



SPECIAL FEATURES

- EX-protection
- Low supply pressure monitoring with contact gauges
- Collective alarm for control room
- Fast system overview

DESCRIPTION

The gas management signal DGM-SK 60 monitors 2 or 4 control circuits for deviation from the norm. This instrument is equipped with a collective alarm to notify a main central office, a control unit (ZLT, SPS, and industry-PC) or an external signalling device. Signal transmitters with the effective direction NC and NO are acceptable. Also the feed lines to the signal transmitters can be monitored for short circuits or cable breaks. An integrated lamp and signal horn allow for testing the correct operation of the instruments. Zero potential contacts (e.g. contact gauges, limit switch) or proximity switches in accordance with NAMUR are suitable as signal transmitters in the control circuits of the SK 60-04. The inherently safe control circuits for the signal transmitters are galvanically separated from the power supply and suitable for the use in explosion prone areas. Additional series connection units such as an Ex-isolating switching unit are not necessary. The alarm signal activates an optical (LED) and acoustic (buzzer) signal. A buzzer is set off for each new alarm which must be acknowledged by pressing a button (acoustical early warning). The optical signal does not switch off until all malfunctions have been remedied.

TECHNICAL DATA

CONNECTION LOAD

Power supply:	230V AC, 50Hz, 5VA; 110V AC, 60Hz
Fuse:	32 mA T, Type Wickmann 19201
Note:	defective fuses may only be replaced by the manufacturer

INLETS

Signal transmitter:	zero potential, mechanical contacts, initiators comply with DIN 19234 (NAMUR)
Effective direction:	operating current or closed circuit current principle e.g. closed or open mechanical contact
Connection system:	2 wires
Signal transmitter supply:	10 V max. throughout the instrument, 10 mA max. (short circuit proof)
Max. load/circuit:	410 mH / 3.0 µF (EEx ia IIC); 1000 mH / 20 µF (EEx ib IIB)
Cable monitoring (optional):	Short circuit I > 6 mA, cable break I < 80 µA

EX PROTECTION

Types of protection:	II G, EEx ia IIB, EEx ia IIC, EEx ib IIB, EEx ib IIC
----------------------	--

OUTLET (COLLECTIVE ALARM)

Alarm output:	relay output (1 change over contact)
Contact load:	max. 230 V ~, 50 Hz, 100 VA, max. 48 V , 1A

INTERNAL ALARM EQUIPMENT

Signal lamp:	LED red 4 mm
Acoustic alarm:	Piezo buzzer, 3.3 kHz
Collective alarm:	via zero potential break contact

AMBIENT CONDITIONS

Ambient temperature:	max. 40 °C
Humidity:	0 - 95 % rel. humidity, not condensing

DESIGN

Housing:	Polystyrene, RAL 7035
Protection category:	IP 54
Dimensions (w×h×d):	166×160×82.5 mm
Installation position:	upright, outside the Ex area!
Cable glands:	blue: 1 each of PG 9 and PG 11 grey: 1 each of PG 11 and PG 13.5
EX protection:	applicable operating material in compliance with EN 50014 and EN 50020 (1977 +A1-A5)

APPLICATION

The SK 60 is used for all kinds of alarm signalling, predominantly for monitoring gas supply or metered flow in gas applications. Monitoring of gas supply can be done by controlling the upstream or downstream pressure (using contact gauges), the weight of the bottle or through monitoring rupture disks, dependent upon model as many as 4 channels can be monitored simultaneously. Flow-switches, floaters or mass flow controllers are suitable as signal transmitters for the monitoring of metered flow. The Ex-protection allows for the operation of this instrument even in explosion prone rooms.

AVAILABLE ACCESSORIES

Solenoid valve control and regulator DGM-MV, contact gauges, mass flow controller, cylinder scales, rupture disks, floater, flow switch and cable monitoring.

INSTALLATION

The housing is designed for wall mounting. Four mounting holes are provided in the back of the housing for this purpose. These can be accessed by unscrewing the cover.

ORDER CODE

Type	Power supply	Ex -protection
DGM-SK 60-04	220	0
DGM-SK 60-04	220 = 230V 50 Hz	0 = without
DGM-SK 60-02	110 = 110V 60Hz	Ex = with

SOLENOID VALVES DGM MV-05 /-10



Solenoid valve control and regulation

SPECIAL FEATURES

- Operates 5/10 solenoid valves
- On-Off by means of a key operated switch
- Emergency shutdown function and collective actuation
- Collective alarm for the control room
- Increased plant security
- Improved user-friendliness
- Fast system overview
- Simple installation and operation

DESCRIPTION

The solenoid valve control is equipped with five/ten output channels which make it possible to control and monitor solenoid valves. Furthermore there is an input channel for emergency shutdown and two zero potential signals for a higher signal such as DDC, PLC.

As soon as voltage is applied to the solenoid valve control the green operating LED lights up and signals that it is operational. The MV (solenoid valves) are activated using the key switch "On" or deactivated using the key switch "Off". If the emergency shutdown is activated, all solenoid valves are switched off and the red emergency shutdown LED flashes. In addition an acoustic signal is emitted which can be reset using the Reset button.

APPLICATION

The solenoid valve control MV-05/MV-10 is a control unit which controls and regulates solenoid valves on individual pressure cylinders and multiple cylinder bundles. The MV-05/MV-10 has been constructed to be fail-safe using state-of-the-art technology and takes into account the relevant regulations and EC guidelines.

The solenoid valve control MV-05/MV-10 is used to actuate solenoid valves for gas cylinder stations and to monitor their functional capability. In the case of a malfunction of any solenoid valve the operator is notified both optically and acoustically on the control unit.

TECHNICAL DATA

Power supply:	230 V AC, 50 Hz, 5 VA
Fuse:	3,15 A slow-blow solenoid valve output; 5 * relay output with 1 fine fuse protection each
Signal output:	2 * relay output (1 change-over contact)
Max. contact load AC:	230 V ~, 50 Hz, 100 VA
Max. contact load DC:	48 V, 1 A
Signal lamp:	LED red, green 5 mm
Acoustic alarm:	Piezo buzzer, f = 3.3 kHz
Ambient temperature:	40° C max.
Humidity:	0 – 95 % relative humidity, not condensing
Housing:	Polystyrene, colour similar to RAL 7035 (light grey)
Protection category:	IP 54
Dimensions:	240×160×90 mm (w×h×l)
Installation position:	upright, outside the Ex-area
Connection cross section:	2.5 mm ² max.
Cable glands:	13 each PG11

ACCESORIES

Signal box DGM-SK, relay box DGM IT and operation terminal DGM-AX for gas management system, mass flow controller, cylinder scales, rupture disks, floater, flow switch and cable monitoring.

INSTALLATION

The housing of the solenoid valve control is designed for wall mounting. Four mounting holes are provided in the back of the housing for this purpose. These can be accessed by unscrewing the cover.

GAS MONITORING SOFTWARE GASCOM

Software for control and automated supervision of gas supply and gas stock

SPECIAL FEATURES

- Visualising of system status
- Automated control processes
- Gas stock management
- Fault and cost reduction
- Statistic and archive functions
- Flexible adaptation of the software to the customer's processes
- Realisation of customer specified functions

APPLICATION

The GasCom serves in monitoring the many functions of a high purity gas supply system and comes with an integrated gas management module including cylinder storage management allowing for tighter cost control. It is increasingly important to deliver coherent and customer oriented gas supply concepts to satisfy the rising cost controls and effective work scheduling. An automation concept compatible with high-purity gas supply is a fundamental component of this. The GCEDruVa GasCom software leaves nothing to be desired.

FUNCTIONS

VISUALISING OF SYSTEM DATA

- Display of pressure data

SYSTEM MONITORING

- GAS MONITORING: Sensor monitoring of cylinder, lines and extraction pressures and consumption, pressures at individual connection points, current certificate data, status display, fault and warning log files (viewable online via an internet browser)
- individual low supply pressure alarm for each gas line with optional pressure range
- Pressure testing with analysis for individual areas
- Integration of supply panels and/or gas supply racks

REMOTE CONTROL

- Password protected dialog for flexible access right assignment in three stages: user, manager, administrator

AUTOMATION OF CONTROL PROCESSES

- Storage of gas cylinder data for each station
- Generating automated order suggestions
- E-mail order process coupled to low gas supply warnings
- Event triggered e-mails
- Triggering of gas equipment specific functions

FAULT AND COST REDUCTION

- Minimising of downtime due to "over seen" empty gas cylinders
- Prevention of double entry mistakes (e.g. gas certificate data) through intelligent interfaces

ARCHIVE FUNCTION AND STATISTICAL ANALYSIS

- Where was each gas cylinder connected and at what time?
- Logging of events and measured data
- Variable logging intervals
- Automatic recording of pressure in the log data
- Automatic recording of all triggered actions in the log data
- Automatic saving of fault and system-warnings in the log data
- Automated documentation for quality control
- Saving and documentation of cylinder certificates data via link-up with professional SQL-data banks
- Gas consumption measuring

SYSTEM REQUIREMENTS

- Standard PC, 2 GHz, 512 MB memory, Windows XP

EXPANDABILITY ACCORDING TO SYSTEM REQUIREMENTS

- Language choices German / English

ORDER INFORMATION

Please contact GCEDruVa for further information



GasCom, main screen



GasCom, stock control and pressure levels, status displays of switching stations, initiating of purge cycles, emergency shut-offs

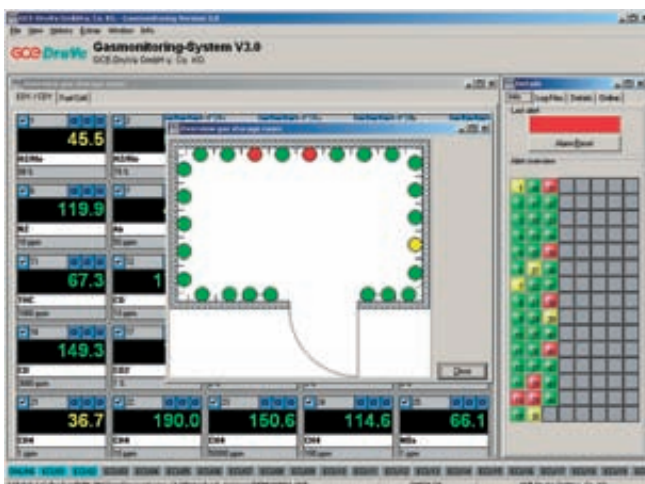

GasCom, graphic display of cylinder pressure with alarm functions and low supply pressure displays

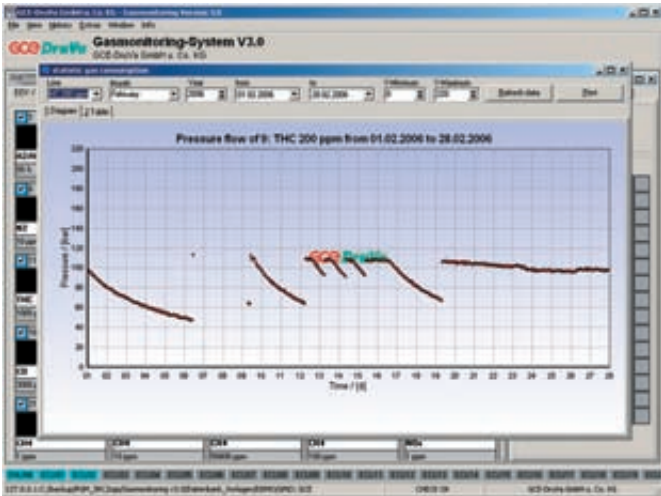

GasCom, monitoring the consumption and system leak tightness

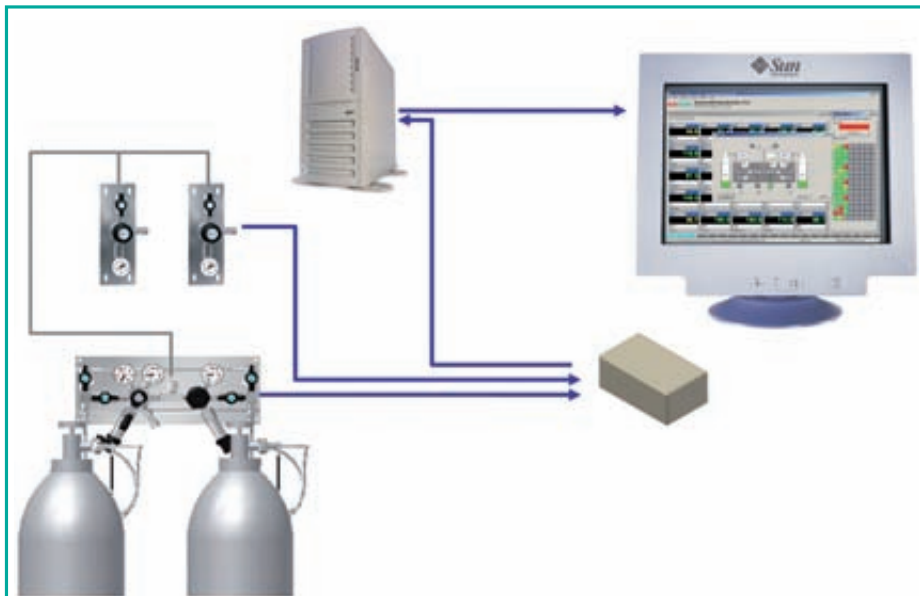

Location-independent monitoring through the Internet or Intranet, remote diagnostics of the central gas supply, archiving of system data, order triggering

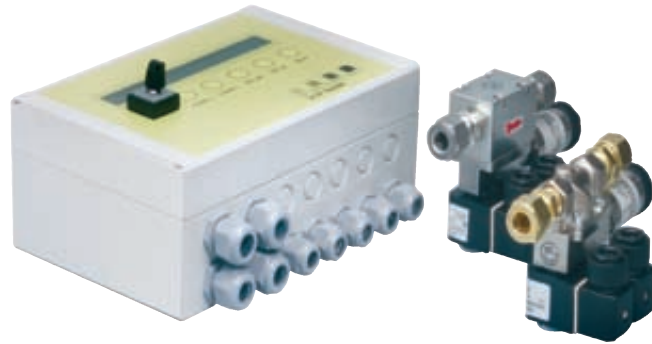

Gas safety protection system, for the monitoring and safeguarding of supply systems for non corrosive, high purity gases and acetylene

SPECIAL FEATURES

- Closed-position monitoring of all downstream point-of-use armatures during start-up
- Monitoring of all downstream supply networks for pipe breakage or damage during operation
- Monitoring of all downstream supply networks and unwanted pressure increase during operation
- System checks for pressure drop after working hours
- Integrated data storage for fault analysis and operational statistics
- Emergency shut-off
- Self testing of the GSPS

TECHNICAL DATA

CONTROL UNIT

Surface mounted housing:	ABS – plastic (UL 94 HB) white
Dimensions:	240x160x90mm (W/H/L)
Voltage:	230 V / 50 Hz
Operation:	Foil-keypad with key switch
Display:	Text display 2x40 characters, illuminated background
Outlet:	zero-potential contact for collective fault reporting
Cable feed:	From bottom via PG fitting

PRESSURE TRANSDUCER

Materials:	housing: stainless steel 1.4305, Trenn diaphragm: Ceramic Al2O3, Griffing: Dural, Seal: EPDM
Inlet:	0 – 16 bar
Outlet:	4 – 20 mA / 2– conductor
Voltage:	12 – 36 V DC, 12 – 28 V DC (EX-version)
Protection class:	IP 67, Ex – protection II 1 G EEX ia lic T 4/4
Electrical connection	Plug M 12x1 (4– pole)
Mech. connection:	G1/4" EN 837-1/-3

VALVES

Nominal width:	DN 0.5 / DN 10
Ambiant temperature.:	-30°C to +60°C
Materials:	Brass (valve body), nickel-plated Brass (valve body) Stainless steel, 1.4305 (valve body)
Diaphragm:	EPDM (CrNi), NBR (Brass), Viton (SS)
Connection:	G3/8" inside thread
Inside cleaning:	Free of oil and grease (US- cleaning GCE-spec. 16.05.02)
Power supply/	
Protection class:	230V / 50 – 60Hz / IP 65 EEX m II T4
Electrical connection:	power socket DN 43650 with rectifier IP65 sealed connection cable L = 3.0m (EX-version)

DESCRIPTION

In effect the device provides the following functions: during the start up and times of operation the downstream pipe network is monitored for gas leakage, tube breakage and damage. At the same time the system is continuously tested for pressure increase (e.g. pressure regulator, valve defect). Air holes, or rather, downstream pressure deviations are therefore identified immediately. The signal box, with integrated data storage, saves a history of operations. Making statistics available for safety purposes. Personnel endangerment is prevented through monitoring any incident of system failure and automatic emergency shut-down (integration in the central security system of the buildings management).

After working hours the pressure consistency is continually tested and if necessary an automatic shut-off of leaky systems is assured. The GSPS valve unit can be room or floor based or centrally arranged. To conform to the safety concept of the operator as well as the size of the installation.

APPLICATION

Pursuant to the current pressure equipment guidelines, the operator of the equipment is responsible for the correct operation and tightness, as well as the operator's safety. The GSPS fulfils not only monitoring and safety functions in accordance with the prevailing norms and safety regulations but also raises, through the extensive functions, the safety of the operation. Thus the GSPS is of particular importance, notably for the use with toxic and flammable gases (e.g.: C₂H₂; H₂; O₂) in central gas supply equipment. Leakage are practically ruled out by continuous monitoring during and outside the times of operation. The time and effort for maintenance and testing is through early warning, realised in this way, system faults are reduced to a minimum.

ORDER CODE

Type	Connetion	Material	Operational pressure	Ex. Protection	Type	Circuits CU
GSPS	10	MV	120	EEX	GSPS-SK	1
	10 = DN 10, 3/8" f 15 = DN 15, 1/2" f 20 = DN 20, 3/4" f 25 = DN 25, 1" f	MV = brass Ni/Cr M = brass E = stainless steel	120 = max 12 bar / 175 psi 15 = max. 1.5 bar / 22 psi (Acetylene) 2 = max. 0.2 bar / 3 psi (Noble gas)	EEX = for use in EX-protected areas KA = protection class IP 65	Control unit	1 = Control unit single channel 2 = Control unit dual channel EEX = EX – channel, for use of

SAFETY CYLINDER CABINETS



**Security cabinets,
in accordance with norm DIN EN 14470 -2,
for 1 to 4 50-liter-cylinders**

SPECIAL FEATURES

- Installation in workrooms
- Highest possible fire-protection in accordance with type class G90
- Flexible cylinder brackets for 10L and 50L cylinder
- Integrated air extraction
- Flexible positioning of gas panels
- Additional lead-thoughts for sensors, cables etc.
- Self-sealing in case of fire

DESCRIPTION

Safety cabinets, type tested, are manufactured in multiple wall constructions out of steel plates with embedded fire protection plates of certified, quality-controlled insulating material. Mounting rails for the armatures, cylinder brackets, etc. are included in delivery. The flexible interior fittings allow for the deployment of all standard gas cylinders. In case of fire, the cabinet contents poses no further danger and makes no contribution to the spread of fire, during a defined period. The cabinet forms a containment of the protection area around the pressure gas cylinders in accordance with TRG 280. Integrated inlet and extraction openings close automatically in the case of fire. The identification/labelling comply with ISO 3864. During installation of the cabinets there are construction requirements to be observed: 10-times air exchange is necessary for flammable and oxidizing gases and 120-times air exchange for toxic gases. The pressure drop should not be more then maximum 150 Pa. Local potential equalization should be observed.

APPLICATION

For secure storage of gas cylinders when: gas cylinders need to stay in the workroom even after shut-down time, it is not possible to realise the necessary protection area (acc. TRG) for lack of space, but continuous gas supply is essential, and/or short pipework is necessary.

ORDER CODE

Type	Outside dimentions (WxDxH)
SC 600	600×617×2050 mm
SC 900	900×617×2050 mm
SC 1200	1200×617×2050 mm

PROTECTIVE CYLINDER CABINETS



Sheet steel cabinet for outdoor gas cylinder storage, for 1 - 4 50 liter cylinders.

SPECIAL FEATURES

- In accordance with TRG 280
- Corrosion proof steel sheet housing for use outdoors
- Height adjustable cylinder brackets for 10L and 50L cylinder
- Flexible armature mountings
- Doors with air vents top and bottom
- Grooved sheet metal floor
- Inspection window available as accessory

DESCRIPTION

Sheet steel cabinets are constructed as a single-walled structure with complete galvanized and plastic-coated, structured surface, offer protection from the effects of weather and unauthorised use. Ventilation in accordance with TRG is found at the bottom of the doors and in the back wall. Connection to the on-site ventilation (NW 75) is prepared. Included in delivery is mounting rails for the armatures, cylinder bracket. Available on request are: fixed or hinged inspection windows, additional shelving, documentation pouch, etc. the flexible interior fittings allow for the storage of all standard gas cylinders.

APPLICATION

For the safe housing of gas cylinders in outside areas.

ORDER CODE

Type	Outside dimensions (WxDxH)	Cylinder max.
OD600	600x596x1997 mm	1 - 2 (50l)
OD1200	1200x596x1997 mm	1 - 4 (50l)

CYLINDER PRESSURE REGULATORS FMD 500-14 IP



**Single-stage,
to increase gas purity to minimum 6.0,
inlet pressure 230 bar / 3300 psi,
downstream pressure range 0.2 - 6 bar / 3 - 85 psi**

SPECIAL FEATURES

- With integrated filterelement
- Diaphragm regulator

DESCRIPTION

The FMD 500-14 IP consists of a cylinder connection, pressure regulator, inlet and outlet gauges, relief valve, outlet connection and integrated, replaceable filter element, which increases the gas purity. The TÜV-certified, diffusion resistant filter offers high cleaning capacity, universal application and long life-span. The need for a replacement is indicated in good time and clearly visible by way of discolouration of the indicator.

APPLICATION

The FMD 500-14 IP with filter element is always deployed where gas purity must be higher than 6.0 and cost-effective, optimum analysis results are wished for.

TECHNICAL DATA PRESSURE REGULATOR

Body:	stainless steel 316L (1.4404) specially cleaned and electro-polished or brass
	CW614 (CuZn39Pb3) specially cleaned, nickel-plated and chrome-plated
Seat seals:	PCTFE
Seals:	PCTFE, PVDF (Brass)
Relief valve seat seals:	FKM, (EPDM, FFKM)*, EPDM, (FKM)*
Pressure gauge range:	-1 - 10 bar (-15 - 145 psi), 0 - 315 bar (0 - 4500 psi)
Basic design aspects:	see page 13
Weight:	approx. 2.8 kg
Dimensions (wxhxd):	approx. 225x240x125 mm

*upon request

PERFORMANCE VALUES OF FILTERS

Type	Filtration	Max. flow (l/min)	H ₂ O (gr)	Cap. O ₂ (ml)	Hydrocarb. (gr)	approx. life span
GC-Moisture	Moisture	25	15			> 3 years
GC-Oxygen	Oxygen	25		2000		> 3 years
GC-Hydroc.	Hydrocarbons	25			24 (as n-Butane)	> 3 years
GC-Combo.	Moisture + Oxygen	25		7	12 (as n-Butane)	> 2 years
GC-Triple	Moisture + Oxygen + Hydrocarb.	25	4	1000	8 (as n-Butane)	> 2 years

APPLICATIONS

Type	Filtration	H ₂ O Application	O ₂ (gr)	Hydrocarb. (gr)	Flow rate	approx. Life span
GC-Moisture	Moisture	Resonator Laser Gas	7.2	-	-	> 1 year
GC-Oxygen	Oxygen	Resonator Laser Gas	-	1000	-	> 1 year
GC-Hydroc.	Hydrocarbons	Resonator Laser Gas	-	-	12	> 1 year
GC-Triple	Moisture + Oxygen + Hydrocarb.	Resonator Laser Gas	1.8	500	4 (as n-Butane)	> 0.5 years

ORDER CODE REGULATOR

Type	Material	Upstream pressure	Downstream pressure	Inlet	Outlet	Gas type
FMD 500-14 IP	BC	F	6	DIN	CL6	GAS
FMD 500-14 IP	BC = brass chrome-plated SS = stainless steel steelsteel	F = 230 bar /3300 psi	6 = 0.5 - 6 bar / 7 - 85 psi	DIN, ANSI, NEN, AFNOR, NBN BS 341, CGA, UNI	CL6, CL8** CL 1/8", CL 1/4", NO6	Please specify

** Outlet: CL6 = tube fitting for tube 6 mm, NO6 = hose connector for hose 6 mm inside diameter. Please note the "burst rate chart" when choosing the tube fittings in chapter 5

INLINE FILTER CO



Inline gas purifier with indicator

**Inline filter,
for applications in the chromatography, for laser resonator gases and other high purity gases,
inlet pressure 11 bar / 160 psi**

SPECIAL FEATURES

- Large number of adsorbent agents/combinations are possible
- Maintenance of the gas purity even during the filter replacement
- Super Clean Filter attain minimum 99.9999 purity of the gases
- The filter are in metal and glass (with indicator)
- Brass or stainless steel connections (1/4" or 1/8") available
- TÜV-tested under laboratory conditions

DESCRIPTION

The Super-Clean™ gas filter is diffusion tested, in glass/metal version and purifies gases with a flow rate of max. 12 l/min independent of the inlet quality, from hydrocarbons, oxygen and moisture (all with indicators) to a gas purity higher than 6.0. Available with or without visual display.

APPLICATION

Super-Clean™ gas filter in glass/metal model for laser gases such as helium, oxygen and carbon dioxide, to protect the resonator as well as the high performance, top-quality laser equipment. Super-Clean™ gas filter in glass/metal model purifies die sensitive carrier gases and burner gases from gas chromatography, carrier gas for GC/MS and LC/MS system from hydrocarbons, oxygen and moisture (all with indicators). Available with or without visual display.

TECHNICAL DATA

Gas purity at outlet:	> 6.0
Max. inlet pressure:	11 bar (160 psi)
Inlet/outlet:	Tube fitting 1/8", on request 1/4"
Working temperature:	-40 °C to 65 °C
Max. Flow rate:	12 l/min
Dimensions (lxd):	approx. 270x32 mm

PERFORMANCE VALUES OF FILTERS

Type	Filtration	Used for	H ₂ O (gr)	Cap. O ₂ (ml)	Hydrocarb. (gr)	approx. life span
GC-Moisture	Moisture	ITG*: He, H ₂ , air	15	-	-	> 3 years
GC-Oxygen	Oxygen	ITG	-	2000	-	> 3 years
GC-Hydrocarb..	Hydrocarb.	ITG*: He, H ₂ , air	-	-	24 (as n-Butane)	> 3 years
GC-Combo.	Moisture + Hydrocarb.	ITG*: He, H ₂ , air	10	-	18 (as n-Butane)	> 2 years
GC-Triple	Moisture + Oxygen + Hydrocarb.	ITG*	4	1000	12 (as n-Butane)	> 2 years

*ITG = Inert carrier gas

ORDER CODE

Art.-Nr.	Description
Inline Filter - Stainless steel without Indicator	
C01001	Filter for Moisture
C01002	Filter for Oxygen
C01003	Filter for Hydrocarbons
C01004	Combination filter : Oxygen - Moisture
C01005	Triple filter : Oxygen - Moisture - Hydrocarbons
C01006	gas spec. (He) Triple filter : Oxygen / Moisture / Hydrocarbons
Inline Filter - Glass with Indicator	
C01051	Triple-indicator : Oxygen / Moisture / Hydrocarbons
C01061	gas spec. (He) indicator Oxygen/Moisture/Hydrocarbons
C01041	indicator Oxygen/Moisture for ICP
Inline Filter Parts	
C02002	Click-On Inline Super Clean™ connection 1/8"Brass (2x)
C02011	Click-On Inline Super Clean™ connection 1/8" SS (2x)
C02001	Click-On Inline Super Clean™ connection 1/4"Brass (2x)
C02010	Click-On Inline Super Clean™ connection 1/4" SS (2x)
C03002	Wall mounting accessories (4/pack)
C03001	Replacement special O-rings for "Click-On" connection ; 10/packet
C03003	Special connection for 1/4" Click-On connection

FILTER-SETS FS



Super Clean combination filter-set
for high flow rate

**Filter-set, for pure gases, for high flow rates,
inlet pressure 11 bar / 160 psi,
to improve gas purity, at least to 6.0**

SPECIAL FEATURES

- Only 2 filters needed for hydrocarbon-filtering in LC/MS
- Quick and easy replacement during operation
- Inert and diffusion tight versions
- Early visual saturation warning

DESCRIPTION

Filter units in metal or glass versions, diffusion tight mounted on a plate. The filter can be replaced during operation in seconds without influencing the technical or analytical performance data in any way. Cleans sensitive nitrogen generator gases in the LC/MS-Systems from hydrocarbons to a purity of > 6.0 (99.9999%).

APPLICATION

Raises the productivity from high performance analysis equipment through the minimising of down time and malfunctions, as well as repair and maintenance costs.

TECHNICAL DATA

Inlet /Outlet :	Brass tube fitting 1/4"
Working temperature:	-40 °C to 65 °C
Dimensions filter:	290 mm ×40 mm
Dimensions 1 base plate:	80×100 mm

Type	Filtration	Application	Max. Flow (l/min)	H ₂ O (gr)	O ₂ (ml)	Hydrocarb. (gr)	approx. life span
GC-H ₂ O	Moisture	Reson. Laser Gas	7	7.2	-	-	> 2 Years
GC-Oxygen	Oxygen	Reson. Laser Gas	7	-	1000	-	> 2 Years
GC-CHn	CHn	Reson. Laser Gas	7	-	-	12	> 2 Years
LC-CHn	CHn	Reson. Laser Gas	20	-	-	24	> 0.4 Years
GC-Combo.	Moisture + Oxygen	Reson. Laser Gas	7	7	3.5	-	6 n-butane > 1.5 Years
GC-Triple	Moisture + Oxygen +CHn.	Reson. Laser Gas	7	7	1.8	500	4 n-butane > 1 Year

ORDER CODE

Art.-Nr.	App.	Description
Base plate		
B0010	GC	Base plate for 1 filter
B0020	GC	Base plate for 2 filter
B0021	LC	Base plate- higher flow rate - for 2 filters (N ₂ -filtration)
B0030	GC	Base plate for 3 filter
B0040	GC	Base plate for 4 filter
Filter		
F0101	GC	Filter, H ₂ O, standard, higher flow rate, with indicator
F0102	GC	Filter, O ₂ , standard, higher flow rate, with indicator
F0103	GC	Hydrocarbons filter, standard, higher flow rate, without indicator
F0104	GC	Hydrocarbons filter, standard, higher flow rate, with indicator
F0730	GC	3-filter set (Triple + 2x Hydrocarbons/moisture combo)
F0740	GC	4-filter set (Standard: oxygen, moisture + 2x charcoal)
F0720	LC	2-filter set (Hydrocarbons 2x for LC-MS: N ₂ filtration) - higher flow rate: without indicator
F0722	LC	2-filter set (Hydrocarbons 2x for LC-MS : N ₂ filtration) - higher flow rate: with indicator
F0721	LC	Special moisture filter; 2er Set, higher flow rate
Filter cartridges with combination of adsorbents		
F0301	GC	Filter, triple (O ₂ /moisture/hydrocarbons); carrier gas filtration for FID - ECD - NPD
F0302	GC	Filter, triple: gas spec. He (O ₂ /moisture/hydrocarbons) in GC-MS
F0201	GC	Filter, combo, higher flow rate, (hydrocarbons/moisture); burner gas application
Base plate + cartridge combined with filter adsorbents		
B1040	GC	FID KIT for 4 standard filter, high capacity O ₂ , moisture, 2x hydrocarbons
B1030	GC	FID KIT for 3 filter/base plate: Triple + 2x combo filter (hydrocarbons/moisture)
B1011	GC	MS KIT for He (gas spec.) ;1 filter/base plate, triple set (O ₂ /moisture/hydrocarbons)
B1010	GC	MS, ECD-, FID-, NPD-carrier gas KIT for 1 filter/base plate, triple set (O ₂ /moisture/hydrocarbons)
B1020	GC	Carrier gas KIT for FID, 2 pos. for air & H ₂ (combo set: 2x hydrocarbons/moisture)
B1021	LC	MS KIT for 2 filter/base plate (2x hydrocarbons: N ₂ filtration) - higher flow rate !!: without indicator
B1022	LC	High flow rate special moisture filter KIT for 2 filter/base plate

GC= gas-chromatography, LC = liquid-chromatography

GAS PREHEATERS



LRX 500,
for preheating of inert and non-corrosive gases,
not for flammable gases or oxygen,
inlet pressure max. 230 bar/ 3300 psi

SPECIAL FEATURES

- High performance for gases and liquids
- Electric protector IP66 (EN 60947)

DESCRIPTION

The LRX is a high performance preheating appliance for the central gas supply. It is delivered fully mounted with 1m cable (3x1.5 mm²) and safety power supply plug. The resistor unit is replaceable (in the factory only) with a protective casing of stainless steel.

APPLICATION

The preheating appliance LRX is used to raise the temperature from gases before their entrance in the pressure regulator and to avoid freezing of valves or following equipment. It can also be used to vaporise liquid gases and in particular for use with carbon dioxide, argon and nitrous oxide, as well as with gas mixtures out of non-flammable gases which contain CO₂ or argon.

TECHNICAL DATA

Power supply:	230 V AC / 50 Hz, 500 W
Protection category:	IP 66 (acc. DIN 60947)
Connection:	1 m cable (3x1.5 mm ²)
Outlet temperature:	60 °C / 140 °F
Max. flow rate:	at higher then 10 °C / 50 °F:
	CO ₂ : 10 m ³ /h / 5.9 SCFM
	Argon: 15 m ³ /h / 8.8 SCFM
Temperature limit:	98 °C
Housing:	Brass + copper-plated tube Ø 5x8 (500 W)
Dimensions (wxhxl):	approx. 140x105x220 mm
Weight:	approx. 2.0 kg
Inlet/outlet:	M16x1.336



GVW 200,
for oxygen and inert gases,
inlet pressure max.315 bar / 4500 psi

SPECIAL FEATURES

- High efficiency
- With the safety protection "Equipment as technical work appliance" in accordance with the "Equipment and product safety regulation" (GPSG)

DESCRIPTION

The GVW 250 is delivered with cable including safety power supply plug.

APPLICATION

To preheat oxygen and inert gases at high pressures.

TECHNICAL DATA

Power supply:	230 V - 50 Hz, 200 W
Inlet/outlet:	in accor. with DIN 477 and CEN
Connection:	2 m cable
Protection category:	IP 44
Size:	approx. 150xØ90 mm
Weight:	approx. 2 kg
Inlet/outlet:	NPT 1/4" f
Temperature limit:	80 °C +/- 5 °C
Temperature:	40 °C +/- 3 °C

ORDER CODE

Type	Inlet	Gas type
LRX 500	DIN	GAS
LRX 500	DIN	Please specify
GVW 250	ANSI	
	AFNOR	
	BS341	
	CGA	
	NEN	

CYLINDER SCALE



Cylinder scales



Display unit

**Electronic scales,
for the level metering of gas cylinders,
with alarm output for low supply pressure alarm**

SPECIAL FEATURES

- Very flat construction
- Metering range to 135 kg
- 0.1 % accuracy and high temperature resistance
- Fulfills the highest EMV requirements
- High protection class IP 65 for outdoor use and high humidity
- 3 alarm outputs on display unit

DESCRIPTION

These electronic scales are delivered together with display unit and connection cable. The indicating device offers 3 alarm outputs to the display unit for the low supply pressure alarm.

APPLICATION

For indoor or outdoor use in gas cabinets. The flat design of these scales allows for the installation even under spatially restricted conditions. The high protection class allows for deployment even where heavy condensation occurs. The scales fulfil the highest EMV requirements to guarantee a safe, fault-free and exact operation.

TECHNICAL DATA

SCALES

Measuring range :	27 / 45 / 136 kg - 60 / 100 / 300 lbs
Overrange limit:	115/ 130 / 340 kg
Sensor material, housing:	Chrome nickel steel
Working temperature:	-15 to 50 °C (compensated temperature range)
Accuracy:	< 0.1 % of range
Nonlinearity:	< 0.05 % of range
EX-protection:	ATEX, category 3G, EEx nA/nL II C T4 /T5/T6 X
Protection class:	IP 65(NEMA 4) accord. to IEC 60 529
Dielectric strength:	500 DC V
Auxiliary power:	15 - 30 DC V
Max. output:	< 30 mA
Signal output:	4 ... 20 mA, 2-wire

DISPLAY

Housing:	Polycarbonate, black
Dimensions:	approx. 48×96×98.5 mm
Display size:	45×92 mm
Protection class:	IP 66
Weight:	approx. 300 g
Alarm outlets :	switching output
Switching behavior:	break cutter and shutter, adjustable with keyboard
Power rating:	230 V AC, 3 A
Power consumption:	10 VA
Working temperature:	0 - 50 °C
Auxiliary power:	AC 230 V 50/60 Hz

CONTACT GAUGES KI 50 - NPT 1/4"



Contact gauge with inductive contact (KI), for visual and acoustic warning of low gas supply pressure and to monitor the cylinder pressures; for inert, combustible, oxidizing and corrosive gases and gas mixtures, nominal pressure maximum 230 bar

SPECIAL FEATURES

- Construction conforms to safety regulations EN837-01
- Switching point is freely adjustable in marked area (45°)
- Pressure display at location and signal transmission for recording measured data
- Ex-protection is possible in conjunction with corresponding signal box

DESCRIPTION

These pressure measuring instruments have a robust chrome nickel steel/cooper-zinc-alloy housing in accordance with DIN 16063. When the gas cylinder is empty and by sinking cylinder pressure an inductive contact switch is activated. The switch point, i.e. the pressure level at which the signal should be triggered is freely adjustable within a sector of 45° (at 315 bar type e.g. 38 bar).

To set the switch point the pressure level marking is simply adjusted to the desired switch point.

APPLICATION

Panel and manifolds can be fitted out with contact gauges as an optional. Contact gauges combine the advantages of a local display with the demand for an electric signal transmission. This allows for - in conjunction with special signal boxes - the optical and acoustic warning signal by low gas supply pressure or the monitoring of the line pressure with freely adjustable threshold.

NOTICE ABOUT ELECTRICAL CONNECTIONS

The polarity must be taken into consideration when connecting as the inductive contact is an active electronic component, The KI 50 can only be operated with a special amplifier.

Suitable for operation are: Signal boxes DGM-SK 60 2/4/6/10 Ex *, switch amplifier WE 77/Ex *.

* The deployment of contact gauges in ex-zone 1 is possible with these instruments. When connecting the contact gauges to an existing fault alarm system it is important to check, in the technical manual, if the operation of NAMUR-Initiators is possible. In case of doubt please contact the manufacturer of your equipment

TECHNICAL DATA

Measuring element:	Bourbon tube
Diameter:	50 mm
Design:	Chemical-safety version DIN 16063
Housing:	CrNi-steel/copper-zinc-alloy
Measuring element:	CrNi-steel 1.4571, circular form/copper-zink-alloy
Inspection glass:	Polycarbonate
Accuracy:	Class 2.5 (DIN 16005)
Wrench size:	14 mm
Nominal pressure:	230 bar
Display range:	see gauge scale
Threshold:	Freely adjustable in marked range (45° of the display range from p = 0 originating)
Gas suitability:	All gases
Contact:	inductive slit sensor (in accordance with NAMUR)
Working temperature:	ambient: -25°C to +70°C measuring medium maximum +100°C
Protection class:	II 2 G EEx ia IIC T6, PTB 99 ATEX 2219 X
Switching hysteresis:	+/- 5 % (SEW)
Control behavior:	Contact type 1 (I1), contact of low impedance with increasing pressure
Dimensions (Øxdxh):	50x35x70 mm
Connection:	NPT 1/4"m outside thread

Art.-Nr.	Type/Contact-Type	Material	Display range (bar)	Display range (psi)
H28191103	KI 50- 315 / i1	BC	0 – 315	0 – 4500
H28191101	KI 50- 315 / i1	SS	0 – 315	0 – 4500
H28191203	KI 50- 400 / i1	BC	0 – 400	0 – 5800
H28191201	KI 50- 400 / i1	SS	0 – 400	0 – 5800

CONTACT GAUGES KI 63, KR 63 - NPT 1/4"



**Contact gauge,
with inductive contact (KI) or mechanical reed contact (KR),
for visual and acoustic warning of low gas supply pressure,
to monitor the line pressure,
nominal pressure maximal 200 bar**

SPECIAL FEATURES

- Construction conforms to safety regulations the BG- chemical industry
- Switching point freely adjustable
- One or two switching point models
- Pressure display and signal transmission for recording measured data
- Ex-protection is possible in conjunction with corresponding signal box SK 60

DESCRIPTION

These pressure measuring instruments have a robust chrome nickel steel housing in safety version in accordance with DIN 16006. When the gas cylinder nears empty and by sinking cylinder pressure an inductive contact switch is activated (KI 63) or respectively a mechanical reed contact (KR 63). The switch point, i.e. the pressure level at which the signal should be triggered, is freely adjustable. Both the gauge KI 63 as well as KR 63 are available with one or two switch points and with different contact types. To set the switch point the pressure level marking is adjusted by turning the bayonet ring to the left and removing the viewing glass. The desired value for the switching point is obtained by adjusting the red marking on the outside scale edge. Afterwards the viewing glass is replaced using the bayonet ring.

TECHNICAL DATA

Measuring element:	Bourbon tube
Diameter:	63 mm
Design:	Chemical-safety version
Material:	Housing: SS 1.4301, parts in contact with the measuring medium: SS 1.4571
Accuracy:	Class 1.6
Working temperature:	-25°C to +70°C / -13 °F to 158 °F
Display range:	see gauge scale
Threshold:	Freely adjustable over the whole scale range
Gas suitability:	All gases
Connection:	NPT 1/4"m or VCR 1/4"f

KI 63

Contact:	inductive contact accord. to NAMUR
Connection:	also G 1/4"m for Acetylene: KI 63-40 I1
Protection class:	II 2 G EEx ia IIC T6, PTB 99 ATEX 2219 X
Switching hysteresis :	max 2.5%
Control behavior :	Contact type 1 (I1), contact of low impedance with increasing pressure
	Contact type 2 (I2), contact of high impedance with increasing pressure
Dimensions (Øxdxh):	63x58x90 mm

KR 63

Contact:	Reed contact, magnet. actuated inert gas contact
Applied load:	10 W / 100 V / 0.5 A
Switching hysteresis:	max 2.5%
Control behavior KR 63:	Contact type 1 (R1), contact is interrupted by decreasing pressure
	Contact type 2 (R2), Contact is interrupted by increasing pressure
Minium switching margin	
K1/K2 (KR 63-2):	35% of the display range
Dimensions (Øxdxh):	63x50x90 mm

Art.-Nr.	Type / contact type	Material	Display range	
			bar	psi
H28945601	KI 63- 15 / i2	SS	-1 – 15	-14,5 – 220
H28940901	KI 63- 100 / i1	SS	0 – 100	0 – 145
H28941101	KI 63- 250 / i1	SS	0 – 250	0 – 3600
H28900801	KR 63-15 / r2	SS	-1 – 15	-14,5– 220
H28974801	KR 63-100 / r1	SS	0 – 100	0 – 1450
H28974101	KR 63- 250 / r1	SS	0 – 250	0 – 3600

SAFETY GAUGES G 1/4"



With G1/4"m connection, accuracy class 2.5

Art.-Nr.	Type	Material	Display range	
			bar	psi
H28150103	RM 50- 1.5 G	Brass / NI-CR	-1 – 1.5	-14.5 – 21
H28150101	RM 50- 1.5 G	SS	-1 – 1.5	-14.5 – 21
H28170103	RM 50- 2.5 G	Brass / NI-CR	0 – 2.5	0 – 35
H28170101	RM 50- 2.5 G	SS	0 – 2.5	0 – 35
H28170303	RM 50- 6 G	Brass / NI-CR	0 – 10	0 – 145
H28170301	RM 50- 6 G	SS	0 – 10	0 – 145
H28170503	RM 50- 16 G	Brass / NI-CR	0 – 25	0 – 360
H28170501	RM 50- 16 G	SS	0 – 25	0 – 360
H28256003	RM 50- 1.5 G	Brass / NI-CR	-1 – 1.5	-14.5 – 21
H28176001	RM 50- 1.5 G	SS	-1 – 1.5	-14.5 – 21
H28176103	RM 50- 2.5 G	Brass / NI-CR	0 – 2.5	0 – 35
H28176101	RM 50- 2.5 G	SS	0 – 2.5	0 – 35
H28176303	RM 50- 6 G	Brass / NI-CR	0 – 10	0 – 145
H28176301	RM 50- 6 G	SS	0 – 10	0 – 145
H28176403	RM 50- 10 G	Brass / NI-CR	0 – 18	0 – 260
H28176401	RM 50- 10 G	SS	0 – 18	0 – 260
H28176503	RM 50- 16 G	Brass / NI-CR	0 – 25	-14.5 – 360
H28176501	RM 50- 16 G	SS	0 – 25	-14.5 – 360

Gauge with inlet at 6 o'clock, other configurations on request!

SAFETY GAUGES RM 50, NPT 1/4"



With inlet below, accuracy class 2.5

Art.-Nr.	Type	Material	Display range	
			bar	psi
H28160103	RM 50- 1.5 NPT	Brass / NI-CR	-1 – 1.5	-14.5 – 21
H28160101	RM 50- 1.5 NPT	SS	-1 – 1.5	-14.5 – 21
H28160303	RM 50- 5 NPT	Brass / NI-CR	-1 – 5	-14.5 – 70
H28160301	RM 50- 5 NPT	SS	-1 – 5	-14.5 – 70
H28160403	RM 50- 10 NPT	Brass / NI-CR	-1 – 10	-14.5 – 145
H28160401	RM 50- 10 NPT	SS	-1 – 10	-14.5 – 145
H28160603	RM 50- 18 NPT	Brass / NI-CR	-1 – 18	-14.5 – 260
H28160601	RM 50- 18 NPT	SS	-1 – 18	-14.5 – 260
H28160703	RM 50- 25 NPT	Brass / NI-CR	-1 – 25	-14.5 – 360
H28160701	RM 50- 25 NPT	SS	-1 – 25	-14.5 – 360
H28160903	RM 50- 80 NPT	Brass / NI-CR	0 – 80	0 – 1150
H28160901	RM 50- 80 NPT	SS	0 – 80	0 – 1150
H28161103	RM 50- 315 NPT	Brass / NI-CR	0 – 315	0 – 4500
H28161001	RM 50- 315 NPT	SS	0 – 315	0 – 4500
H28161203	RM 50- 400 NPT	Brass / NI-CR	0 – 400	0 – 5800
H28161201	RM 50- 400 NPT	SS	0 – 400	0 – 5800

TECHNICAL DATA - SAFETY GAUGE

Accuracy classes: 2.5 / 1.6, safety level: according with EN 837, diameter: 50 mm (2") / 63 mm (2.48"), Material: Brass nickel-plated and chrome-plated CW614N (CuZn39Pb3), CW508L (CuZn37); CW453K (CuSn8) (Bourdon tube) depending on pressure range, stainless steel 316L (1.4404)

FLASH BACK ARRESTORS



Art.-nr.	Type	Inlet x Outlet	Material	Gas / max. pressure (bar)				
				A*	H	M	O	P
L000337	FS400	G1/4"m x G 1/4"f	Brass	-	10	12	-	8
L000454	FS400	G1/4"m x G 1/4"f	Brass-Cr	1.5	3.5	-	15	-
L000110	FS500	NPT 1/4"f x NPT 1/4"m	SS	1.5	3.5	5	15	5
B000096	FS500	NPT 1/4"m x NPT 1/4"f	Brass	1.5	3.5	-	15	-
B000492	FS500	NPT 1/4"f x NPT 1/4"m	SS	1.5	3.5	5	15	5
B000614	FS500	NPT 1/4"m x NPT 1/4"f	Brass	-	9	12	-	-
B000643	FS500	NPT 1/4"f x NPT 1/4"m	SS	1.5	4	5	-	-
B000892	FS500	NPT 1/4"f x NPT 1/4"m	Brass-Cr	1.5	10	12	-	12

*) Acetylene C₂H₂ (A), Hydrogen H₂ (H), Methane CH₄ (M), Oxygen O₂ (O), Propane C₃H₈ (P)

CYLINDER CONNECTIONS DIN 477



Complete, for FMD series 500 + 320, outlet NPT 1/4"m

Art.-Nr.	Type	Material	Connection thread
H03028855	FA 1	Brass / NI-CR	W 21.8 × 1/14" LH
H030288113	FA 1	SS	W 21.8 × 1/14" LH
H030289113	FA 5	SS	W 1" × 1/8" LH
H03029055	FA 6	Brass / NI-CR	W 21.8 × 1/14"
H030290113	FA 6	SS	W 21.8 × 1/14"
H03029113	FA 7	SS	R 5/8"
H030292113	FA 8	SS	W 1" × 1/8"
H03029355	FA 9	Brass / NI-CR	R 3/4"
H030293113	FA 9	SS	R 3/4"
H03029455	FA 10	Brass / NI-CR	W 24.32 × 1/14"
H030294113	FA 10	SS	W 24.32 × 1/14"
H030295113	FA 11	SS	R 3/8"
H03029855	FA 13	SS	R 5/8"
H030298113	FA 13	SS	R 5/8"
H030296113	FA 14	SS	M 19 × 1.5

CYLINDER CONNECTIONS UNI



Complete, for FMD series 500 + 320, outlet NPT 1/4"m

Art.-Nr.	Type	Material	Connection thread
H03608355	FA UNI 4405	Brass / NI-CR	W 20 × 1/14" Sin.
H03608364	FA UNI 4405	SS	W 20 × 1/14" Sin.
H03608155	FA UNI 4406	Brass / NI-CR	W 21.7 × 1/14"
H03608164	FA UNI 4406	SS	W 21.7 × 1/14"
H03608055	FA UNI 4409	Brass / NI-CR	W 21.7 × 1/14"
H03608064	FA UNI 4409	SS	W 21.7 × 1/14"
H03610450	FA UNI 4412	Brass / NI-CR	W 24.5 × 1/14"
H03610401	FA UNI 4412	SS	W 24.5 × 1/14"

CYLINDER CONNECTIONS BS 341



Complete, for FMD series 500 + 320, outlet NPT 1/4"m

Art.-Nr.	Type	Material	Connection thread
H03915101	FA BS 341 Nr. 2	SS	G 5/8" LH
H03603173	FA BS 341 Nr. 3	Brass / NI-CR	G 5/8"
H03603101	FA BS 341 Nr. 3	SS	G 5/8"
H03612773	FA BS 341 Nr. 4	Brass / NI-CR	G 5/8" LH
H03612701	FA BS 341 Nr. 4	SS	G 5/8" LH
H03755773	FA BS 341 Nr. 8	Brass / NI-CR	0.860" × 14 TPI
H03755701	FA BS 341 Nr. 8	SS	0.860" × 14 TPI

CYLINDER CONNECTIONS NEN 3268



Complete, for FMD Series 500 + 320, inlet see below, outlet NPT 1/4"m

Art.-Nr.	Type	Material	Connection thread
H03609655	FA LU 1	Brass / NI- CR	W 21.8 × 1/14" LH
H036096117	FA LU 1	SS	W 21.8 × 1/14" LH
H03609856	FA LU 4	Brass / NI- CR	W 1" × 1/8" LH
H036098113	FA LU 4	SS	W 1" × 1/8" LH
H03608673	FA RI 2	Brass / NI- CR	G 5/8"
H036086151	FA RI 2	SS	G 5/8"
H03609555	FA RU 1	Brass / NI- CR	W 21.8 × 1/14"
H036095117	FA RU 1	SS	W 21.8 × 1/14"
H03610055	FA RU 3	Brass / NI- CR	W 24.32 × 1/14"
H036100117	FA RU 3	SS	W 24.32 × 1/14"

CYLINDER CONNECTIONS AFNOR



Complete, for FMD series 500+320, outlet NPT 1/4"m

Art.-Nr.	Type	Material	Connection thread
H03303473	FA C	Brass / NI-CR	Ø 21.7 × 1.814
H033034151	FA C	SS	Ø 21.7 × 1.814
H03608873	FA E	Brass / NI-CR	Ø 21.7 × 1.814 LH
H036088151	FA E	SS	Ø 21.7 × 1.814 LH
H03608973	FA F	Brass / NI-CR	Ø 22.91 × 1.814
H036089151	FA F	SS	Ø 22.91 × 1.814

CYLINDER CONNECTIONS CGA



Complete, for FMD series 500 + 320, outlet NPT 1/4"m

Art.-Nr.	Type	Material	Inlet
H03614573	FA CGA 320	Brass / NI- CR	0.825" – 14 NGO RH EXT
H03614501	FA CGA 320	SS	0.825" – 14 NGO RH EXT
H03607673	FA CGA 350	Brass / NI- CR	0.825" – 14 NGO LH EXT
H03607601	FA CGA 350	SS	0.825" – 14 NGO LH EXT
H03619273	FA CGA 540	Brass / NI- CR	0.903" – 14 NGO RH EXT
H03619201	FA CGA 540	SS	0.903" – 14 NGO RH EXT
H03750073	FA CGA 580	Brass / NI- CR	0.965" – 14 NGO RH INT
H03750001	FA CGA 580	SS	0.965" – 14 NGO RH INT
H03607473	FA CGA 590	Brass / NI- CR	0.965" – 14 NGO LH INT
H03607401	FA CGA 590	SS	0.965" – 14 NGO LH INT

CYLINDER VALVES



Inlet pressure max. 50 bar, inlet gas type specific, in accordance with DIN 477, outlet NPT 1/4" f

Art.-Nr.	Design	Material
FAV50036BC50	without gauge	Brass / NI- CR
FAV50036SS50	without gauge	SS
FAV50037BC50	with gauge	Brass / NI- CR
FAV50037SS50	with gauge	SS

PIGTAILS

In accordance with DIN 477/ 230 bar, with hexagon nut, coil tube Ø 6 mm. Material SS/ PCTFE. Outlet, swivel nut M14 × 14.5 or NPT 1/4"m. Pigtail tubing allows for connection of the gas panel with gas supply in a limited spatial area. Built-in handles guarantee a zero potential and gas-tight connections. Cylinder connections also in accordance with other norms such as AFNOR, NEN, ... or 300 bar cylinder on request.



Art.-Nr.	Art.-Nr.	DIN connection
M14×1.5f	NPT1/4"m	
H27415664	H27448064	FA 1
H27415764	-	FA 5
H27415864	H27427364	FA 6
H27416 944	H27462464	FA 7
H27415964	H27446364	FA 8
H27416064	H27433464	FA 9
H27414564	H27433564	FA 10
H27416164	H27433664	FA 11
H27416264	H27433764	FA 13
H27416364	H27433864	FA 14

PIGTAILS



In accordance with DIN 477/ 230 bar, tube Ø 1/8", with hex nut , outlet NPT 1/4"m. material SS/PCTFE. Cylinder connections also in accordance with other norms such as AFNOR, NEN, ... upon request.

Art.-Nr.	DIN Connection
H27430564	FA 1
H27430664	FA 5
H27430764	FA 6
H27430864	FA 7
H27430964	FA 8
H27431064	FA 9
H27431164	FA 10
H27431264	FA 11
H27432264	FA 13
H27431364	FA 14

FLEXIBLE HOSES



In accordance with DIN 477/ 230 bar, with hex nut. Material SS/PCTFE. Inlet see below, outlet M14×1.5f mm or NPT 1/4"m– with swivel nut. For safety reasons the flexible corrugated pipe comes equipped with a safety lines, which prevent uncontrolled whipping in the case of a hose breakage. The advantage of the corrugated pipe is a maximum mobility in relation to the gas supply. Cylinder connections in accordance with other norms such as AFNOR, NEN, ... and 315 bar cylinder models are upon request.

M14,5×1.5f NPT 1/4"m			
Art.-Nr.	Art.-Nr.	DIN	Length
H27427264	H27429564	FA 1	1 m
H27428464	H27449064	FA 5	1 m
H27427764	H27429064	FA 6	1 m
H27428564	H27444864	FA 7	1 m
H27440064	H27431464	FA 8	1 m
H27428764	H27432164	FA 9	1 m
H27427664	H27428164	FA 10	1 m
H27440164	H27435664	FA 13	1 m
H27428864	H27506264	FA 14	1 m
H27428064	H27435464	FA 1	1.5 m
H27447364	H27458164	FA 5	1.5 m
H27427864	H27428364	FA 6	1.5 m
H27428664	H27212264	FA 7	1.5 m
H27447064	H27435564	FA 8	1.5 m
H27427464	H27429362	FA 9	1.5 m
H27427564	H27429664	FA 10	1.5 m
H27427964	H27451664	FA 11	1.5 m
H27429864	H27505364	FA14	1.5m
H27438764	H27451864	FA 1	3 m
H27444564	H27459164	FA 6	3 m
H27439664	H27451964	FA 10	3 m
H27446264	H27995164	FA 13	3 m
H27447964	-	FA 14	3 m

ACETYLENE HIGH PRESSURE CONNECTION HOSES

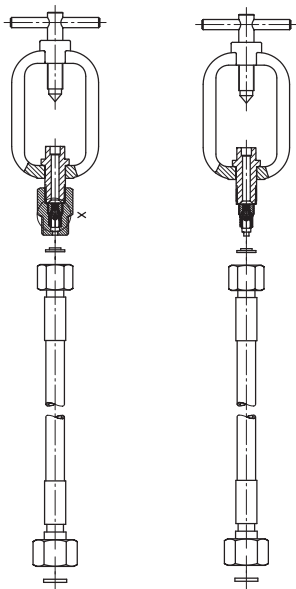

Cylinder hoses with back pressure protection
14037493

Cylinder hoses without back pressure protection
14037334

Application	Version	Length
14037493	Cylinder with back pressure safety	800 mm
14037249	Bundle	RHÖNA 1500 mm
14037841	Bundle	LINDE 1500 mm
14037842	Bundle	MG 1500 mm
14037843	Bundle	Basi 1500 mm

ATTENTION: there is a 5-yearly obligatory testing for acetylene high pressure hoses in accordance with TRAC 204, 5.3.7. These hoses fulfil the requirements according to EN ISO 14113. Further connections upon request.

Bundle connection Rhöna
standard 14.037.190 for AGA

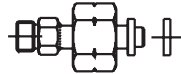

14.037.115 for Linde bundle



14.037.190 for MG bundle

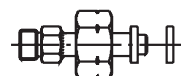

14.037.190 for BASI bundle

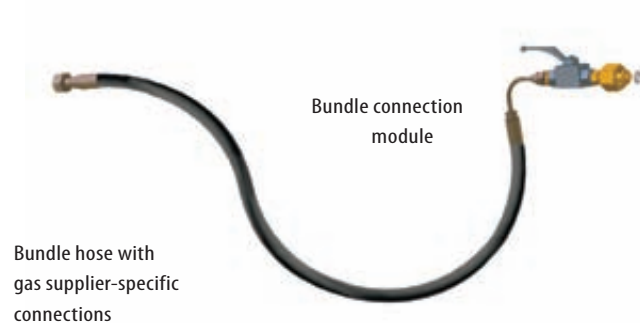

Bundle connection module

Bundle hose with gas supplier-specific connections

ACETYLENE HIGH PRESSURE HOSES

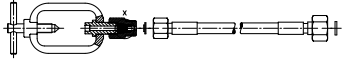

With check valve and cylinder connection. Other connections on request.

Art.-Nr.	Connection
19037002001	DIN 477- 3
19037002002	DIN 477- 12
19037002003	CGA 300
19037002004	AFNOR Type H
19037002005	UNI 4411

TUBE FITTINGS, STRAIGHT



Art. Nr.	Type	Material
H03005103U	NPT 1/4"m x 1/8"	Brass
H03006103U	NPT 1/4"m x 1/4"	Brass
H03001103U	NPT 1/4"m x 6 mm	Brass
H03002103U	NPT 1/4"m x 8 mm	Brass
H03003003U	NPT 1/4"m x 10 mm	Brass
H03004003U	NPT 1/4"m x 12 mm	Brass
H03005101U	NPT 1/4"m x 1/8"	SS
H03006101U	NPT 1/4"m x 1/4"	SS
H03001101U	NPT 1/4"m x 6 mm	SS
H03002101U	NPT 1/4"m x 8 mm	SS
H03003001U	NPT 1/4"m x 10 mm	SS
H03004001U	NPT 1/4"m x 12 mm	SS
A000121U	G 1/4"m x 1/8"	Brass / NI-CR
L000268U	G 1/4"m x 1/4"	Brass / NI-CR
A000123U	G 1/4"m x 6 mm	Brass / NI-CR
A000162U	G 1/4"m x 8 mm	Brass / NI-CR
A000125U	G 1/4"m x 10 mm	Brass / NI-CR
A000127U	G 1/4"m x 12 mm	Brass / NI-CR
A000120U	G 1/4"m x 1/8"	SS
L000264U	G 1/4"m x 1/4"	SS
A000122U	G 1/4"m x 6 mm	SS
A000161U	G 1/4"m x 8 mm	SS
A000124U	G 1/4"m x 10 mm	SS
A000126U	G 1/4"m x 12 mm	SS
H03206103U	G 3/8"m x 1/4"	Brass
H03019303U	G 3/8"m x 6 mm	Brass
H03823803U	G 3/8"m x 8 mm	Brass
H03818603U	G 3/8"m x 10 mm	Brass
H03831103U	G 3/8"m x 12 mm	Brass
H03866301U	G 3/8"m x 1/8"	SS
H03889701U	G 3/8"m x 1/4"	SS
H03019301U	G 3/8"m x 6 mm	SS
H03823801U	G 3/8"m x 8 mm	SS
H03818601U	G 3/8"m x 10 mm	SS
H03831101U	G 3/8"m x 12 mm	SS

TUBE FITTINGS, ELBOW 90°



Art.-Nr.	Type	Material
H03001203U	NPT 1/4"m x 6 mm	Brass
H03002303U	NPT 1/4"m x 8 mm	Brass
H03085203U	NPT 1/4"m x 10 mm	Brass
H03096403U	NPT 1/4"m x 12 mm	Brass
H03001201U	NPT 1/4"m x 6 mm	SS
H03002301U	NPT 1/4"m x 8 mm	SS
H03085201U	NPT 1/4"m x 10 mm	SS
H03096401U	NPT 1/4"m x 12 mm	SS

G 1/4"m x 6, 8, 10, or 12 mm in brass and stainless steel on request !

TUBE FITTINGS, T-SHAPE



Art.-Nr.	Type	Material
H03814703U	3 × 1/8" Tube	Brass
H03900703U	3 × 1/4" Tube	Brass
H03001303U	3 × 6 mm Tube	Brass
H03002803U	3 × 8 mm Tube	Brass
H03003303U	3 × 10 mm Tube	Brass
H03004103U	3 × 12 mm Tube	Brass
H03814701U	3 × 1/8" Tube	SS
H03900701U	3 × 1/4" Tube	SS
H03001301U	3 × 6 mm Tube	SS
H03002801U	3 × 8 mm Tube	SS
H03003301U	3 × 10 mm Tube	SS
H03004101U	3 × 12 mm Tube	SS

TUBE FITTINGS, TUBE END 6 M



Art.-Nr.	Type	Material
H03849603U	6 mm × 1/8"	Brass
H03826103U	6 mm × 3 mm	Brass
H03826203U	6 mm × 4 mm	Brass
H03849601U	6 mm × 1/8"	SS
H03826101U	6 mm × 3 mm	SS
H03826201U	6 mm × 4 mm	SS

Other Tube stub connections available on request !

HOSE NOZZLES, G-THREAD



Art.-Nr.	Type	Material
H03825573U	G1/4"m × 4 mm	Brass / NI-CR
H03825673U	G1/4"m × 6 mm	Brass / NI-CR
H03825773U	G1/4"m × 8 mm	Brass / NI-CR
H03825501U	G1/4"m × 4 mm	SS
H03825601U	G1/4"m × 6 mm	SS

HOSE NOZZLES, HOSE END 6 MM



Art.-Nr.	Type	Material
H03825203U	6 mm × 4 mm	Brass
H03825303U	6 mm × 6 mm	Brass
H03825403U	6 mm × 8 mm	Brass
H03825201U	6 mm × 4 mm	SS
H03825301U	6 mm × 6 mm	SS

ADAPTORS



Art.-Nr.	Type	Material
H03017803U	NPT 1/4"m × G1/4"m	Brass
H03014853U	NPT 1/4"m × G 1/4"f	Brass / NI-CR
H03017801U	NPT 1/4"m × G1/4"m	SS
H03014801U	NPT 1/4"m × G 1/4"f	SS
H03012801U	NPT 1/4"m × VCR 1/4"m	SS
H03013801U	NPT 1/4"m × VCR 1/4"f	SS

HEXAGON BLIND PLUGS



Art.-Nr.	Type	Material
H220032151	NPT 1/4"m	SS
H220121151	G 1/4"m	SS
H220197151	G 3/8"m	SS

GASKETS FOR G-THREADING



Minimum order 25 pcs. PVDF, 10 pcs. PCTFE

Art.-Nr.	Type	Size	Material
H09011816	11.2 × 5.5 × 1.2 mm	G ¼"	PVDF
H09008916	11.2 × 5.5 × 1.5 mm	G ¼"	PVDF
H09011716	11.2 × 5.5 × 1.8 mm	G ¼"	PVDF
H09015716	11.2 × 5.5 × 2.1 mm	G ¼"	PVDF
H09011809	11.2 × 5.5 × 1.2 mm	G ¼"	PCTFE
H09008909	11.2 × 5.5 × 1.5 mm	G ¼"	PCTFE
H09011709	11.2 × 5.5 × 1.8 mm	G ¼"	PCTFE
H09009009	11.2 × 5.5 × 2.1 mm	G ¼"	PCTFE
H09008915	11.2 × 5.5 × 1.5 mm	G ¼"	PTFE
H09015916	14 × 9 × 2 mm	G 3/8"	PVDF
H09010309	14 × 9 × 2 mm	G 3/8"	PCTFE
H09001015	14 × 9 × 3 mm	G 3/8"	PTFE

GASKETS FOR CYLINDER CONNECTIONS



For cylinder connections in accordance with DIN 477 (minimum order 25 pcs. PVDF, 10 pcs. PCTFE)

Art.-Nr.	FA-Nr.	Material
H09015816	1, 6, 7, 9, 10, 12, 13	PVDF
H09010109	1, 6, 7, 9, 10, 12, 13	PCTFE
H09010216	5, 8	PVDF
H09010209	5, 8	PCTFE
H09015916	11, 14	PVDF
H09010309	11, 14	PCTFE

GLOVES, TRANSPARENT

Single-use, minimum order 25 pcs.

Art.-Nr.	Material	Size
W619000	Latex	S, or 6 – 7
W619100	Latex	M, or 7 – 8
W619200	Latex	L, or 8 – 9
W656100	Latex strengthened	9 – 9 ½
W649400	Plastic, white	XL

GASKETS FOR M14×1.5 MM

Minimum order 25 pcs.

Art.-Nr.	Type	Material	Dimensions
H17000112	O- Ring	EPDM	6 × 2 mm
H17000111	O- Ring	FKM	6 × 2 mm
H09001116	Seal	PVDF	10 × 6 × 2 mm
H09001109	Seal	PCTFE	10 × 6 × 2 mm

CHECK VALVES



Art.-Nr.	Material	Inlet	Outlet
H45002060	SS/ FKM	M 14 × 1.5 mm	NPT ¼"m
H03882603	Brass/ Buna	NPT ¼"f	NPT ¼"m
H03882601	SS/ Viton	NPT ¼"f	NPT ¼"m
B000638	SS/ FKM	6 mm	NPT ¼"m
B000727	SS/ EPDM	6 mm	NPT ¼"m

RELIEF VALVES

Direct acting, spring loaded valve, to safely release excess pressure.
inlet NPT ¼"m, outlet NPT ¼"f,



Art.-Nr.	Type	Material	Activating Pressure
B000645	SB/ 8 N	Brass/ NI+CR/ EPDM	8 bar
B000646	SS/ 8 N	SS/ FKM	8 bar
B000631	SB/ 15 N	Brass/ NI+CR/ EPDM	15 bar
B000632	SS/ 15 N	SS/ FKM	15 bar
B000636	SB/ 60 N	Brass/ NI+CR/ EPDM	60 bar
B000635	SS/ 60 N	SS/ FKM	60 bar

PLASTIC HOSES

Available in lengths of 10m

Art.-Nr.	inside Ø × outside Ø	Material
H28800019	6 mm × 4 mm	Polyethylene
H27505015	6 mm × 4 mm	Teflon
H27505115	8 mm × 6 mm	Teflon
H27505215	10 mm × 8 mm	Teflon

VALVE MOUNTINGS

For valves MVA 500, MVK 41, MVR 500, MVA 501

Art.-Nr.	Type	Material
H05018204	For wall mounting	Aluminium
H05023905	Retaining bracket	Steel

MOISTURE FILTERS

Recommended for chloric gases such as HCL, BF₃, etc.

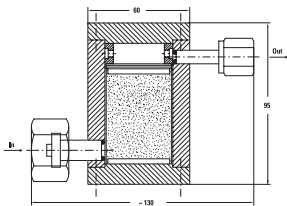

Art.-Nr.	Type	Description
H51000164	TF 750	Filter housing filled with molecular sieve
H03108364	TF 750	Filter insert

FLOW METERS, WITH REGULATING VALVE



With metering valve, delivery includes conversion table, inlet/outlet NPT ¼" f

AIR

Art.-Nr.	Type	Material	Flow rate [l/h] at 1 bar (20°C)
H28030070	DK 800	Brass/ FKM	6 – 60
H28028270	DK 800	Brass/ FKM	25 - 250
H28028370	DK 800	Brass/ FKM	50 - 500
H28033170	DK 800	Brass/ FKM	240 - 2400
H28030060	DK 800	Brass/ VITON	6 – 60
H28028260	DK 800	Brass/ VITON	25 - 250
H28028360	DK 800	Brass/ VITON	50 - 500
H28033160	DK 800	Brass/ VITON	240 - 2400

N₂ AND H₂

Art.-Nr.	Type	Material	Flow rate [l/h]
H28032970	DK 800 for N2	Brass/ VITON	600 – 6000 at 1 bar (20°C)
H28032360	DK 800 for H2	SS/ VITON	16 – 160 at 2 bar

flow meters for other gases available on request.

HEATING SLEEVE



For FMD series 230 and 500. illustration with FMD 500-14.

Art.-Nr.	Type	Description
H28650119	ZB 500- Sleeve	230 V
H28650019	ZB 500- Sleeve	115 V

CYLINDER HOLDER



Art.-Nr.	Type	Description
H03110301	FH	profiled stainless steel sheet with belt
H03050220	Belt	replacement belt for cylinder holder

ADJUSTMENT KNOBS FOR PRESSURE REGULATORS AND VALVES

Art.-Nr.	Type
H111004201	Replacement adjustment knob pressure regulator, black, Series 500
H110073201	Replacement adjustment knob shut-off valve, 90° black, Series 500
H110080201	Replacement adjustment knob regulating valve, black, Series 500
H040520204	Guide sleeve for replacement adjustment knob, Series 500
H110060204	Guide sleeve for valve, Series 500
H22005219	Screw for Series 500
321813960150	Replacement adjustment knob pressure regulator, black, Series 230
311112220612	Screw for Series 230
H110090210	Replacement adjustment knob pressure regulator, Series LAB 3000
H110091210	Replacement adjustment knob shut-off valve, Series LAB 3000
H110092210	Replacement adjustment knob regulating valve, Series LAB 3000

SERVICE

Type

Electrochemical polishing of metal parts
Ultrasonic Cleaning
Orbital Welding of stainless steel
Flow rate measuring
Repair Training for pressure regulator and valves
Service contracts for high purity gas systems

LABELS, SERIES 500, ADJUSTMENT KNOB + VALVE

For valve and pressure regulator adjustment knob, GCEdruVa models

Art.-Nr.	Type	Material	Diameter
H21003604	for adjustment knob	PVC	Ø 30 mm
H21027304	for valve	PVC	Ø 17 mm

LABELS, SERIES 300, 400 AND 500

For valve and pressure regulator adjustment knobs, colour coding in accordance with DIN 12920

Type	Material	Diameter	Note
Label for valve	PVC	Ø 17 mm	Indicate gas type
Label for adjustment knob	PVC	Ø 30 mm	Indicate gas type

LABELS, SERIES 3000

Pressure regulator adjustment knob gas specific, please indicate gas type!

Art.-Nr.	Type	Material	Diameter
LabelLAB3000	for adjustment knob	PVC	Ø 21 mm
H21047004	for shut-off valve	Anodized Alu	Ø 12 mm
H21047104	for regulating valve	Anodized Alu	Ø 14 mm

LABELS FOR SMD/ BMD/ EMD

Gas specific, connection thread: 80 mm × 25 mm, please indicate gas type!

Art.-Nr.	Type	Material
H21049519	Self-adhesive laminate	PVC

LEAK-DETECTION SPRAY

Art.-Nr.	Type	Description
W619600	Leak detection spray	400 ml Canister DVGW

TEFLON TAPES

Art.-Nr.	Type	Material	Description
W635600	Teflon tape, width 1.5	PTFE	12 m × 12 mm × 0.1 mm
W635500	Teflon tape, width 1.6	PTFE	13.7 m × 12.3 mm × 0.1 mm

По вопросам продаж и поддержки обращайтесь:

Архангельск (8182)63-90-72
Астана (7172)727-132
Астрахань (8512)99-46-04
Барнаул (3852)73-04-60
Белгород (4722)40-23-64
Брянск (4832)59-03-52
Владивосток (423)249-28-31
Волгоград (844)278-03-48
Вологда (8172)26-41-59
Воронеж (473)204-51-73
Екатеринбург (343)384-55-89

Иваново (4932)77-34-06
Ижевск (3412)26-03-58
Казань (843)206-01-48
Калининград (4012)72-03-81
Калуга (4842)92-23-67
Кемерово (3842)65-04-62
Киров (8332)68-02-04
Краснодар (861)203-40-90
Красноярск (391)204-63-61
Курск (4712)77-13-04
Липецк (4742)52-20-81

Магнитогорск (3519)55-03-13
Москва (495)268-04-70
Мурманск (8152)59-64-93
Набережные Челны (8552)20-53-41
Нижний Новгород (831)429-08-12
Новокузнецк (3843)20-46-81
Новосибирск (383)227-86-73
Омск (3812)21-46-40
Орел (4862)44-53-42
Оренбург (3532)37-68-04
Пенза (8412)22-31-16

Пермь (342)205-81-47
Ростов-на-Дону (863)308-18-15
Рязань (4912)46-61-64
Самара (846)206-03-16
Санкт-Петербург (812)309-46-40
Саратов (845)249-38-78
Севастополь (8692)22-31-93
Симферополь (3652)67-13-56
Смоленск (4812)29-41-54
Сочи (862)225-72-31
Ставрополь (8652)20-65-13

Сургут (3462)77-98-35
Тверь (4822)63-31-35
Томск (3822)98-41-53
Тула (4872)74-02-29
Тюмень (3452)66-21-18
Ульяновск (8422)24-23-59
Уфа (347)229-48-12
Хабаровск (4212)92-98-04
Челябинск (351)202-03-61
Череповец (8202)49-02-64
Ярославль (4852)69-52-93

Единый адрес: gec@nt-rt.ru | <http://gce.nt-rt.ru>